

# **SAN FRANCISCO**

## **PUBLIC UTILITIES COMMISSION**

### **CONSTRUCTION BEST MANAGEMENT PRACTICES HANDBOOK**

**AUGUST 2013**



# TABLE OF CONTENTS

---



## INTRODUCTION

- 1.1 Overview of Handbook
- 1.2 BMP Selection



## EROSION AND SEDIMENT CONTROL

- 4.1 Soil Preparation and Roughening
- 4.2 Rolled Erosion Control Products
- 4.3 Hydraulic Mulch
- 4.4 Straw Mulch
- 4.5 Wood Mulching
- 4.6 Hydroseeding
- 4.7 Soil Binders
- 4.8 Sodding
- 4.9 Diversion Structures
- 4.10 Slope Drains
- 4.11 Check Dams
- 4.12 Inlet and Catch Basin Protection
- 4.13 Fiber Rolls
- 4.14 Silt Fence
- 4.15 Gravel Berm
- 4.16 Sediment Trap
- 4.17 Active Treatment Systems (ATS)



## CONSTRUCTION SITE PLANNING AND MANAGEMENT

- 2.1 Scheduling and Planning
- 2.2 BMP Inspection and Maintenance
- 2.3 Preservation of Existing Vegetation



## NON-STORMWATER AND WASTE/MATERIAL MANAGEMENT

- 5.1 Water Conservation
- 5.2 Concrete Management
- 5.3 Paving and Grinding Operations
- 5.4 Material Delivery and Storage
- 5.5 Stockpile Management
- 5.6 Sanitary Waste
- 5.7 Hazardous Waste
- 5.8 Solid Waste
- 5.9 Liquid Waste
- 5.10 Spill Prevention and Control
- 5.11 Contaminated Soil
- 5.12 Paint and Stucco
- 5.13 Illicit Connection/Discharge
- 5.14 Dewatering Operations



## VEHICLE TRACKING AND DUST CONTROL

- 3.1 Stabilized Construction Access
- 3.2 Stabilized Construction Roadway
- 3.3 Tire Wash
- 3.4 Street Cleaning
- 3.5 Dust Control



## APPENDIX

- 6.1 Standard Notes for Erosion Control Plan
- 6.2 Sample Erosion and Sediment Control Plan



# BEST MANAGEMENT PRACTICES





# INTRODUCTION



## IN THIS CHAPTER:

- 1.1 Overview of Handbook
- 1.2 BMP Selection
  - Selection Tool
  - Erosion and Sediment Control Plan Overview
  - Sample Construction Sites

# 1.1 OVERVIEW OF HANDBOOK

## OVERVIEW

Construction sites can be significant sources of pollution. Harmful materials from construction sites such as concrete, mortars, paint chips, and other debris can wash into storm drains. As a result, these pollutants reach the bay, local lakes, and the ocean, triggering serious water quality concerns.

This handbook is intended to help guide contractors and property owners manage construction in a manner that protects San Francisco's bay and waterways. This handbook provides technical guidance for both temporary and permanent erosion prevention, sediment control, and management of other activities that can cause pollution during construction. These methods are divided into four categories: Construction Site Planning & Management, Vehicle Tracking & Dust Control, Erosion & Sediment Control, and Non-Stormwater & Waste/Material Management.



Mud is removed from a delivery truck prior to leaving the site.

# 1.1 OVERVIEW OF HANDBOOK

## BACKGROUND

This handbook describes the Best Management Practices (BMPs) aimed to reduce pollutants at the source. The suite of BMPs presented in this handbook are designed to prevent the discharge of sediment laden runoff from a site. These practices can also be used to divert runoff away from contaminated areas or to treat stormwater runoff before discharging to sewer/storm drain.

There are two main classifications of BMPs for construction projects: “Erosion & Sediment Control” and “Non-Stormwater and Waste/Material Management.”

### Erosion & Sediment Control BMPs:

- Minimize disturbed areas
- Stabilize disturbed areas
- Protect slopes and channels
- Control site perimeter
- Retain sediment

### Non-stormwater and Waste/Material Management BMPs:

- Practice good housekeeping
- Contain and safely dispose materials and waste

## HANDBOOK ORGANIZATION

The handbook is organized with the following sections:

- Construction Site Planning and Management, pg. 17
- Vehicle Tracking and Dust Control, pg. 27
- Erosion and Sediment Control, pg. 35
- Non-Stormwater and Waste/Materials Management, pg. 67

The BMPs included in this handbook are only a sample of the practices commonly used today. BMP technology is constantly changing, and new methods of protection are frequently available.



Disturbed soils on the hillside were stabilized with vegetative growth and fiber rolls.



## 1.2 BMP SELECTION

### OVERVIEW

Since every construction project is unique, the BMPs selected for each site will depend on the specific site conditions and construction activities. For project sites larger than one acre, projects are required to comply with guidelines set forth by the California State Water Resources Control Board (SWRCB).

All sites should have the following BMPs:

- Scheduling & Planning
- Inspection & Maintenance
- Water Conservation
- Sanitary Waste
- Spill Prevention & Control
- Illicit Connection & Discharge
- Dewatering Options
- Street Cleaning

A selection tool for the other BMPs mentioned in this handbook is available for use on the next page. Sample exhibits have been developed to provide guidance for planning BMPs on various types of project sites.



This site requires waterspraying or a soil stabilizer to minimize dust.

# BMP SELECTION TOOL

Project Conditions													
	Contaminated Soils	Steep Slopes	Existing Storm Inlets, Drains	Short Term (1 year or less)	Long Term (greater than 1 year)	Sensitive Vegetation	Industrial	Exposed Soils	On Site Vehicle Traffic	Landscape Grading	Street/Sidewalk Grading	On Site Material Storage	
Best Management Practices	Preservation of Existing Vegetation					X				X	X		
	Stabilized Construction Access			X	X			X	X				
	Stabilized Construction Roadway				X			X	X				
	Tire Wash							X	X				
	Dust Control		X					X	X	X	X		
	Soil Preparation									X			
	Rolled Erosion Control Products		X	X	X	X				X	X		
	Mulch		X		X	X		X		X			
	Hydroseeding		X			X				X			
	Soil Binders		X		X	X		X		X			
	Sodding		X					X		X			
	Diversion Structures		X	X									
	Slope Drains		X	X									
	Check Dams		X		X					X	X		
	Inlet and Catch Basin Protection			X									
	Fiber Rolls		X	X			X			X	X	X	
	Silt Fence		X	X			X			X	X	X	
	Gravel Berm		X								X		
	Sediment Trap			X									
	Active Treatment Systems			X	X	X		X					
	Concrete Management										X	X	X
	Paving and Grinding Operations										X	X	X
	Material Delivery and Storage				X	X		X			X	X	X
	Stockpile Management				X	X		X			X	X	X
Hazardous Waste	X			X	X		X			X	X	X	
Solid Waste				X	X		X			X	X	X	
Liquid Waste			X	X	X		X			X	X		
Contaminated Soil	X						X			X	X	X	
Paint and Stucco												X	

# EROSION AND SEDIMENT CONTROL PLAN OVERVIEW

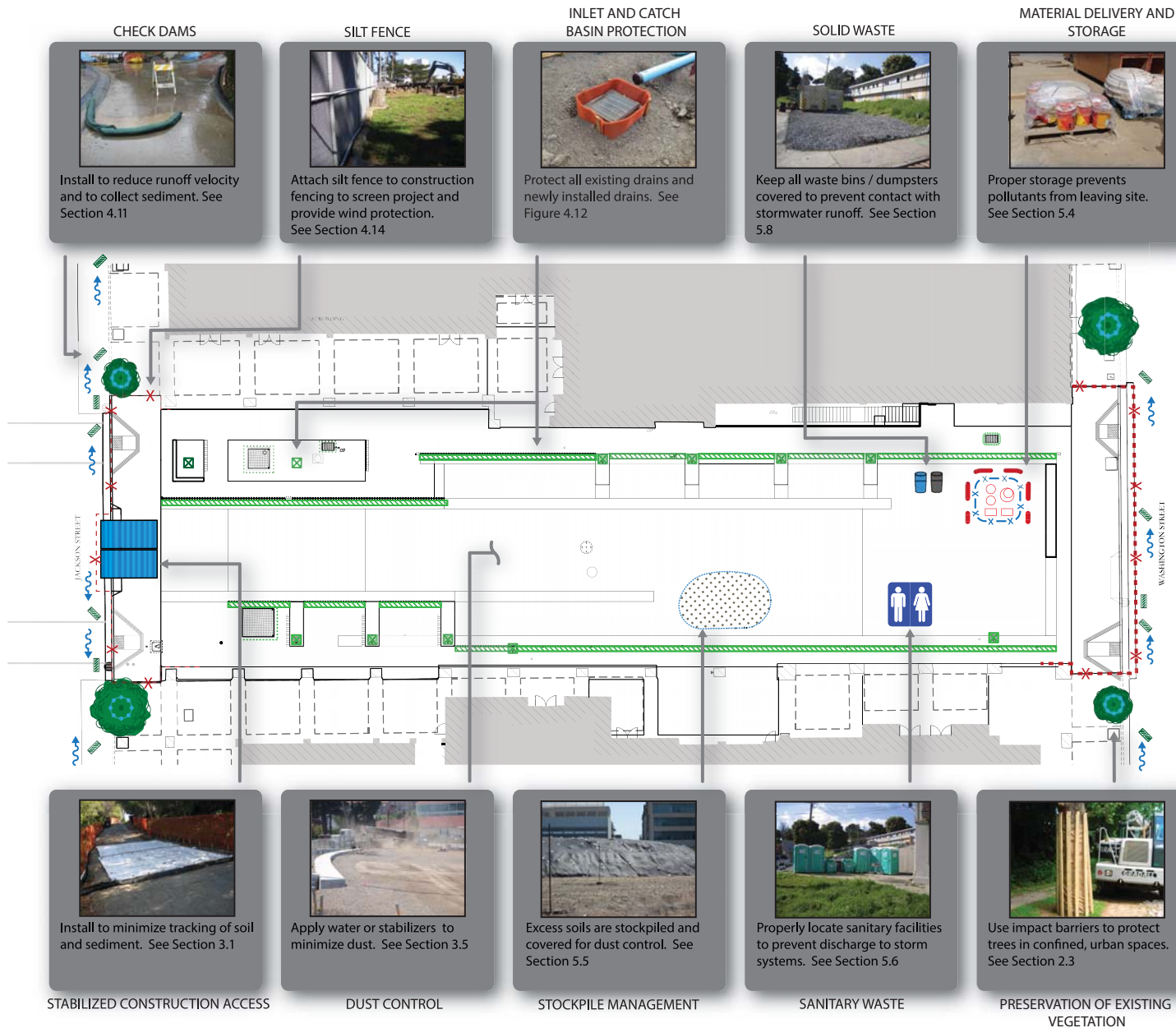

**CHECK DAMS**



Install to reduce runoff velocity and to collect sediment. See Section 4.11

**SILT FENCE**



Attach silt fence to construction fencing to screen project and provide wind protection. See Section 4.14

**INLET AND CATCH BASIN PROTECTION**



Protect all existing drains and newly installed drains. See Figure 4.12

**SOLID WASTE**



Keep all waste bins / dumpsters covered to prevent contact with stormwater runoff. See Section 5.8

**MATERIAL DELIVERY AND STORAGE**



Proper storage prevents pollutants from leaving site. See Section 5.4

**STABILIZED CONSTRUCTION ACCESS**



Install to minimize tracking of soil and sediment. See Section 3.1

**DUST CONTROL**



Apply water or stabilizers to minimize dust. See Section 3.5

**STOCKPILE MANAGEMENT**



Excess soils are stockpiled and covered for dust control. See Section 5.5

**SANITARY WASTE**



Properly locate sanitary facilities to prevent discharge to storm systems. See Section 5.6

**PRESERVATION OF EXISTING VEGETATION**



Use impact barriers to protect trees in confined, urban spaces. See Section 2.3



# SINGLE FAMILY RESIDENCE



- 1 PROTECTION OF EXISTING VEGETATION - Protect trees around site. Use wood impact barriers in confined areas. See Section 2.3
- 2 SANITARY WASTE - Provide sanitary facilities on or near the site. Wastes must be transported offsite by licensed sanitary service providers. See Section 5.6
- 3 STREET CLEANING - Remove debris from street and sidewalk by sweeping or vacuuming. See Section 3.4
- 4 CHECK DAM - Place in street gutter to reduce runoff velocity and collect sediment. See Section 4.11
- 5 GREEN INFRASTRUCTURE - Protect all upstream and downstream permanent BMPs (i.e. bioretention areas, planters, stormwater management facilities) from construction sediment.
- 6 PAINT AND STUCCO - Cover and contain all paint materials. See Section 5.12

# HIGH DENSITY RESIDENTIAL

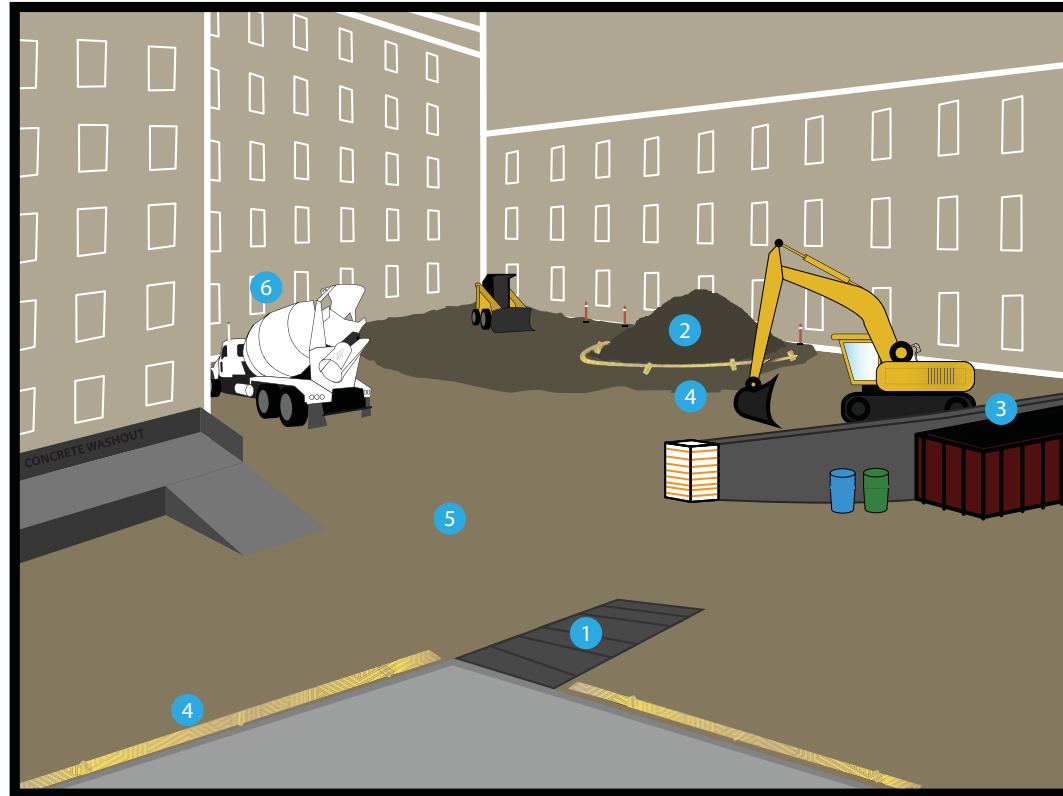

- 1 STABILIZED CONSTRUCTION ACCESS - Install rock pad, mat or rumble plates at entrance to site to prevent tracking of soils onto nearby streets. See Section 3.1
- 2 STOCKPILE MANAGEMENT - Cover and protect excess site materials, provide perimeter protection. See Section 5.5
- 3 SOLID WASTE - Contain all waste in appropriate storage bins. See Section 5.8
- 4 FIBER ROLLS - Place fiber rolls around stockpiles to filter sediment from runoff. See Section 4.13
- 5 DUST CONTROL - Apply water to piles and exposed soil to prevent dust generation. See Section 3.5
- 6 CONCRETE MANAGEMENT - Follow guidelines in Section 5.2 to eliminate concrete production wastes from leaving site.

# INDUSTRIAL

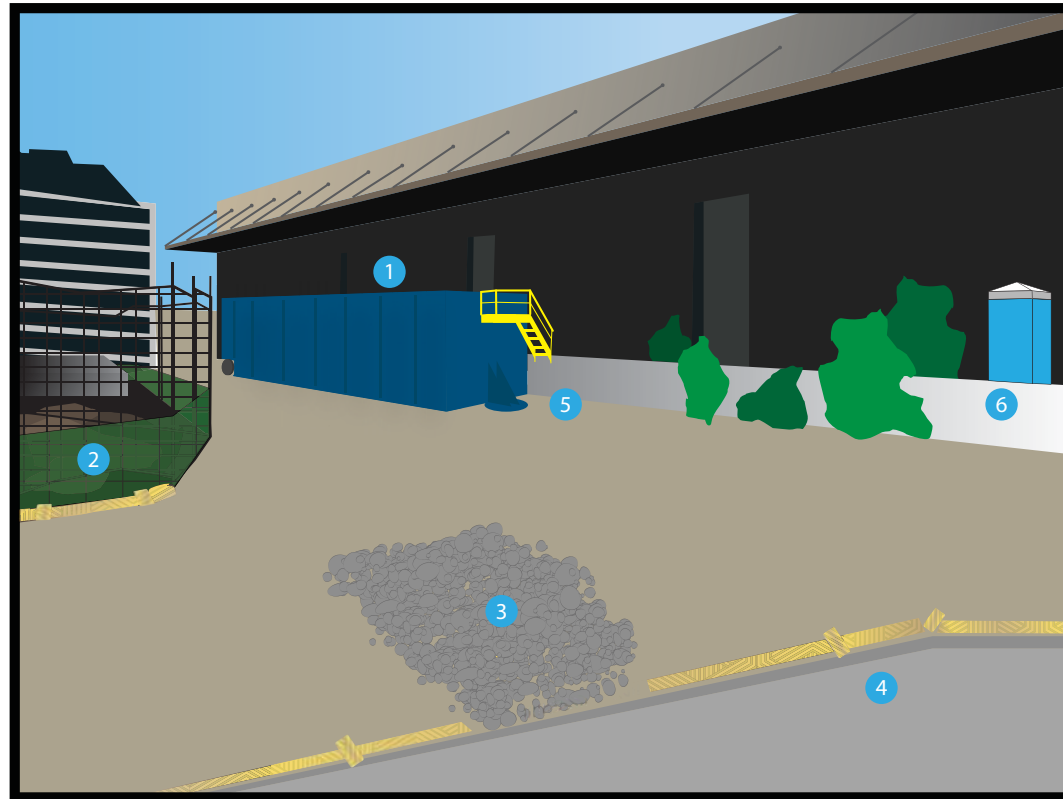

- |  |  |
|--|--|
| <p><b>1</b> DEWATERING OPERATIONS - Install dewatering tank on site to treat collected site runoff. See Section 5.14</p>                                     | <p><b>4</b> STREET CLEANING - Sweep or vacuum tracked debris. See Section 3.4</p>                        |
| <p><b>2</b> SILT FENCE - Attach silt fence to construction perimeter fence. See Section 4.14</p>   | <p><b>5</b> CONTAMINATED SOIL - Test all suspected soils at a certified laboratory. See Section 5.11</p> |
| <p><b>3</b> STABILIZED CONSTRUCTION ROADWAY - Install temporary gravel roadway at entrance / exit. Remove when construction is complete. See Section 3.2</p> | <p><b>6</b> PAINT AND STUCCO - Cover and contain all paint materials. See Section 5.12</p>               |



# PLAZA AND STREETSCAPING

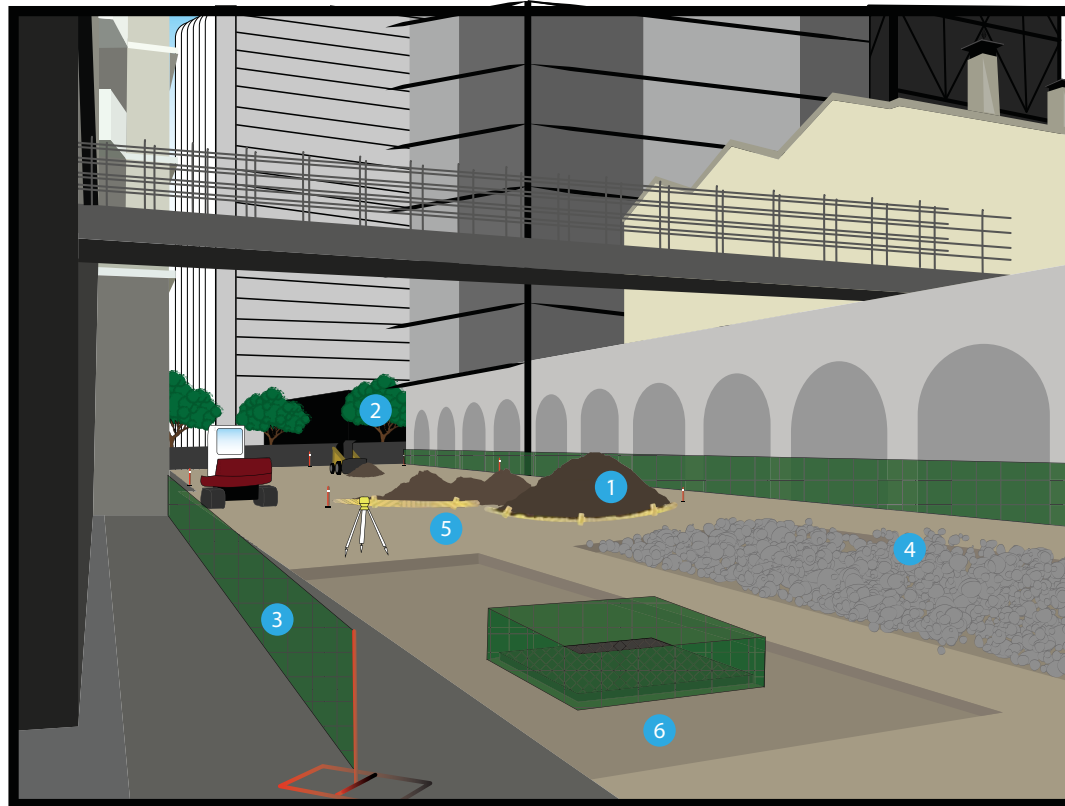

- 1 STOCKPILE MANAGEMENT- Cover and protect excess site materials, provide perimeter protection. See Section 5.5
- 2 PRESERVATION OF EXISTING VEGETATION - Protect trees in and around the site. Use impact barriers in more urban sites. See Section 2.3
- 3 SILT FENCE - Attach to construction fence to provide security and wind protection. See Section 4.14
- 4 STABILIZED CONSTRUCTION ACCESS - Provide stabilized access that reduces tracking of soils and sediment. See Section 3.1
- 5 DUST CONTROL - Apply water to piles and exposed soil to prevent dust generation. See Section 3.5
- 6 INLET AND CATCH BASIN PROTECTION - Protect all existing and newly installed drains, inlets and utility vents. See Section 4.12

# PARKS AND GREEN SPACE



- 1** PRESERVATION OF EXISTING VEGETATION - Provide protection fencing around all trees and plants to remain. See Section 2.3
- 4** CONCRETE MANAGEMENT - Provide concrete washout during pouring procedures. See Section 5.2
- 2** SILT FENCE - Attach silt fence to construction fencing. See Section 4.14
- 5** FIBER ROLLS - Place rolls at perimeter of work to filter out sediment from runoff. See Section 4.13
- 3** GREEN INFRASTRUCTURE - Protect all upstream and downstream permanent BMPs (i.e. bioretention areas, planters, stormwater management facilities) from construction sediment.
- 6** HYDROSEEDING - Apply hydroseed to cleared and graded areas for temporary vegetation. See Section 4.6

# BEST MANAGEMENT PRACTICES



# CONSTRUCTION SITE PLANNING AND MANAGEMENT



## IN THIS CHAPTER:

- 2.1 Scheduling and Planning
- 2.2 BMP Inspection and Maintenance
- 2.3 Preservation of Existing Vegetation



## 2.1 SCHEDULING AND PLANNING

### DESCRIPTION

Coordinating BMP implementation with construction activities is critical in preventing erosion and sediment loss. All construction sites, regardless of size, should have a pre- and post- construction schedule. This allows a connection to the sequence of construction and the installation of erosion and sediment control measures. Developing a written plan and specified work schedule for implementing BMPs is a key objective of planning.

### DEVELOPMENT OF EROSION AND SEDIMENT CONTROL PLAN

Before designing a plan and schedule, gather the project's background information including soil type, drainage, previous uses, location details and site topography. This information helps determine appropriate BMPs for the site. Once BMPs have been selected, an Erosion and Sediment Control Plan should be developed for the site and updated throughout the duration of the project's construction. This plan should include a drawing of the construction site with the locations of all BMPs, construction and installation details, and appropriate notes. See Appendix A, Section 6.2 for an example plan. An implementation and sequencing plan is provided on pages 19 and 21.



A contractor inspecting the site during a rain event.



## 2.1 SCHEDULING AND PLANNING

### BMP IMPLEMENTATION AND SEQUENCING

#### 1. BEFORE CONSTRUCTION

Identify and protect critical vegetation including trees, associated rooting zones and vegetation areas. Identify vegetative buffer zones between the site and sensitive areas, and other areas to be preserved. Hold a pre-construction meeting to discuss the specifics of erosion and sediment control measures and construction limits. If required, ensure that a Qualified Stormwater Pollution Prevention Plan Practitioner has been assigned to the project. Ensure that all construction staff have been informed, are trained, and have been provided with a copy of the project SWPPP.

#### 2. SITE ACCESS AREAS

Stabilize site entrance and exit access roads prior to start of construction.

#### 3. INSTALL SEDIMENT CONTROL MEASURES

Establish material and waste storage areas, concrete washouts and other non-stormwater controls prior to start of construction activities.

#### 4. NON-STORMWATER POLLUTION CONTROL MEASURES

Establish material and waste storage areas, concrete washouts, and other non-stormwater controls prior to start of construction activities.

#### 5. RUNOFF CONTROL

Construct the primary runoff control measures to protect areas from concentrated flows. Runoff becomes a concentrated flow when it accumulates into a defined channel.

#### 6. LAND CLEARING AND GRADING

Begin land clearing, excavation, trenching, or grading after installing applicable sediment and runoff control measures. Install additional control measures as needed.

#### 7. SURFACE STABILIZATION

Apply temporary or permanent soil stabilization measures on all disturbed areas as grading progresses.

#### 8. CONSTRUCTION AND PAVING

Erosion and sediment control measures should remain in place for the duration of construction, including protection for storm drain inlets and appropriate non-stormwater pollution controls.

#### 9. FINAL STABILIZATION AND LANDSCAPING

Provide permanent erosion prevention measures on all exposed areas and remove temporary measures as areas are stabilized.

**NOTE:** The above sequence is provided as a general example. It assumes routine inspection, maintenance and replacement of BMPs, as needed.



Workers vacuum liquid waste from drilling activities.

## 2.1 SCHEDULING AND PLANNING

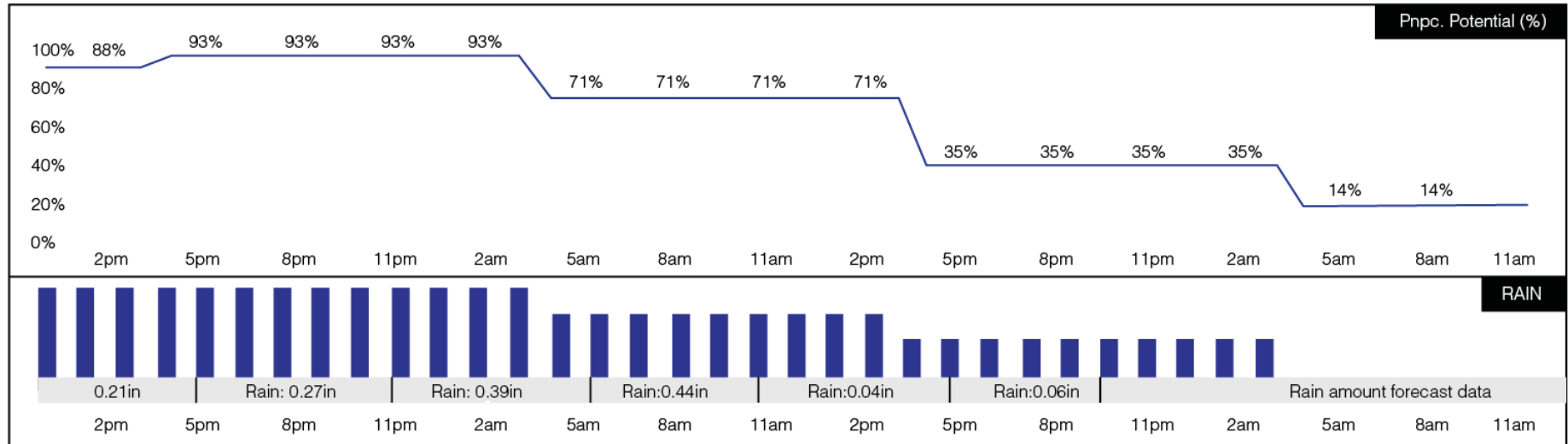

Weather forecasts can be downloaded from the NOAA website. Rainfall can be predicted 48 hours in advance.

### WEATHER

There are several micro-climates within San Francisco. As a result, pay close attention to local weather reports when developing the construction schedule. Certain construction activities such as grading, foundation work and paving should not be conducted during the rainy season which typically runs from October to April. If activities like grading continue into the rainy season, the length of time that soils are exposed must be minimized. Additional measures for erosion and sediment control such as rock bags, sediment fences and fiber rolls should always be kept on site in case of immediate need.

Weather forecasts that include rainfall predictions can be found on the National Oceanic and Atmospheric Administration (NOAA) website. This is a helpful tool for larger projects when completing rainfall monitoring in accordance with the Construction General Permit.

# EXAMPLE PROJECT PHASING AND IMPLEMENTATION

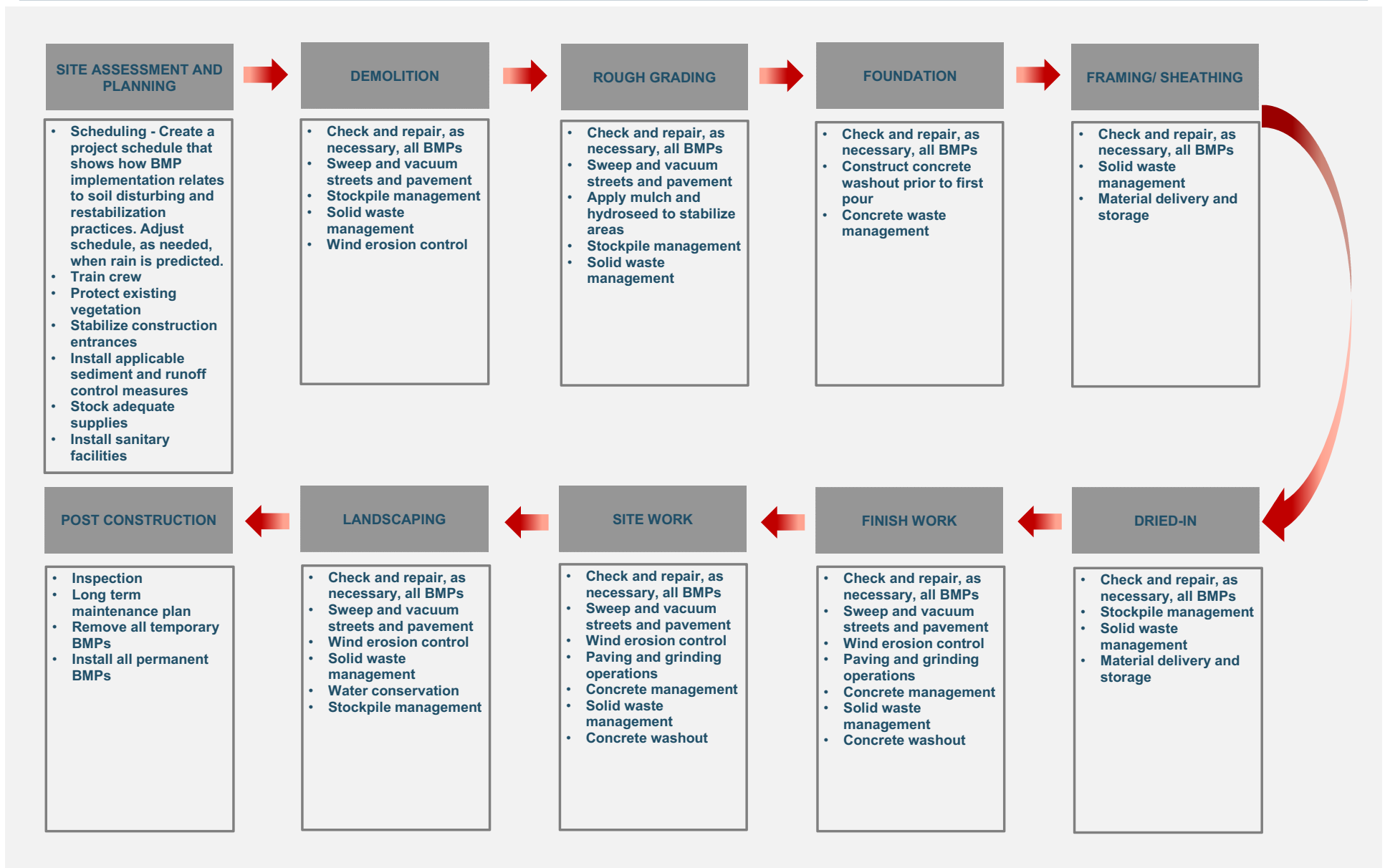

## 2.2 BMP INSPECTION AND MAINTENANCE

### DESCRIPTION

Maintenance guidelines for all specified BMPs should be provided on the Erosion and Sediment Control Plans. Routine inspections and maintenance ensure that BMPs function properly and help prevent construction site runoff discharges. BMP maintenance training for on-site workers is a critical factor in an effective erosion and sediment control program. Proper training on general erosion and sediment control principles can expedite identification of maintenance issues and repairs.

### GUIDELINES

Projects that disturb over an acre of land must submit a Notice of Intent with the SWRCB and comply with the operation, maintenance and inspection guidelines set forth in the Construction General Permit.

### ROUTINE INSPECTIONS

Construction site activities can damage BMPs. Routine inspections are necessary to ensure the integrity and effectiveness of BMPs, and helps protect a site from unexpected weather events. Project owners or contractors should perform daily inspections to identify BMPs in need of maintenance. Upon identifying failures or other maintenance items, contractors should implement repairs or design changes to BMPs within 72 hours of identification and complete the changes as soon as possible.



The BMP at this drain inlet needs replacement and ongoing maintenance. Sediment, debris and other pollutants can easily enter the storm drain system.



This drain inlet is completely unprotected while construction activities are conducted close by, allowing pollutants to enter the storm drain.



## 2.2 BMP INSPECTION AND MAINTENANCE

### BEFORE RAIN EVENTS

To prepare for rain events, contractors should walk the construction site and ensure that BMPs are cleaned and operating properly. Verify that dumpsters are covered, paint and other chemicals are covered, and no oil spills are present. Contractors should also visually inspect all BMPs when the site will be inactive for several days. This will help prepare for rains that might occur when workers are absent from the site. Planning and preparation minimize the risk of on- or off-site property damage occurring because of inoperative or malfunctioning BMPs.

### DURING RAIN EVENTS

During rain events, contractors should be prepared to inspect the performance of erosion and sediment control measures, and implement corrective actions. Appropriate materials and equipment should be kept on hand to affect a rapid response.

### AFTER RAIN EVENTS

After a rain event, prepare the site for the next storm. Within 48 hours after rain, inspect, clean, and repair the site's BMPs. To prevent health and safety hazards, remove mud in traffic areas and remove standing water. A rain event is over when there are 48 hours without any precipitation. A post event inspection should be completed, and indicated repairs and maintenance completed within 72 hours.



Maintenance is required on this dirt and debris filled construction access.



Workers are cleaning the access area to allow the BMP to function effectively.



## 2.3 PRESERVATION OF EXISTING VEGETATION

### DESCRIPTION

Prior to the start of any construction activities, it is critical to identify and protect trees and existing vegetation. Trees and vegetation are effective for erosion and sediment control, watershed protection, dust and pollution control, and landscape preservation.

### GUIDELINES

The Erosion and Sediment Control Plan should clearly show the areas of vegetation and trees to be protected. The appropriate fencing or protection barrier will also be identified on these plans. The figures on the next page show two examples of tree protection. The wood impact barrier is appropriate for the more urban sites in San Francisco where space is limited and trees are often located within sidewalk areas. Wrapping tree trunks with straw wattles should help protect existing trees within dense project areas. During contractor supplied erosion and sediment control training, work crews should learn how to install and maintain these protective measures. To further support vegetation protection, the following construction activities should not be conducted or located within and around the barrier of the protected areas:

- Parking, vehicle access areas, stockpiles and storage areas
- Trenching
- Heavy equipment, vehicular traffic, or storage of construction materials

### MAINTENANCE

During construction, the limits of disturbance should remain clearly marked at all times. All protective measures must remain in place, and restored immediately if damaged. Once all construction activity has been completed, the measures can be removed, and reused or disposed of properly. In areas that allow it, orange construction fencing should also be placed at the drip line of trees to clearly mark protected areas.

### TREE REMOVAL PERMIT

- A permit is required before any street tree or significant tree – alive, dead or hazardous – can be removed. For each tree removed, a replacement tree planting is required. For more information, please contact the San Francisco Bureau of Urban Forestry.
- A list of Designated Landmark Trees can also be found at the San Francisco Department of Public Works site. These trees are designated by the city for landmark status and are protected from physical damage and removal.



Existing vegetation is protected with fiber rolls and silt fence.



An existing tree is protected with fiber rolls and perimeter fencing.

## 2.3 PRESERVATION OF EXISTING VEGETATION

### TREE PROTECTION FENCING

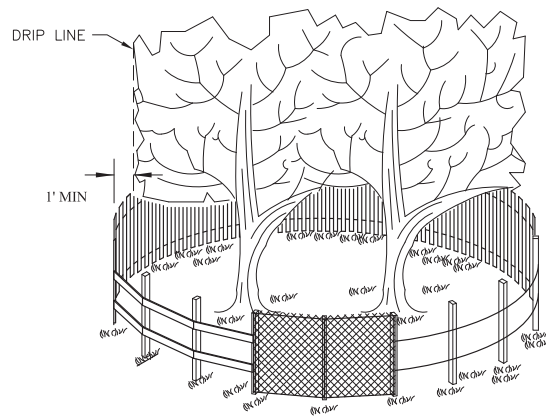

### WOOD IMPACT BARRIER

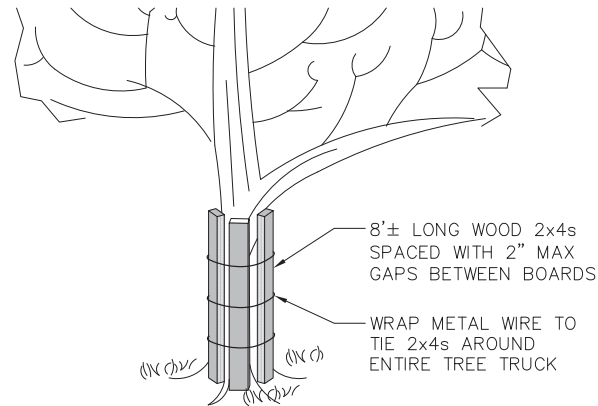

### POST AND FENCE DETAIL

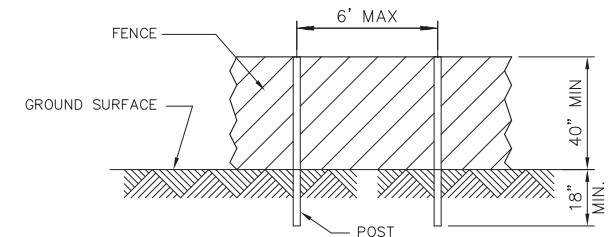

#### NOTES:

1. The fence shall be located a minimum of 1 foot outside the drip line of the tree to be saved and in no case closer than 5 feet to the trunk of any tree. Arborist or landscape architect to approve any exceptions.
2. Fence posts shall be either standard steel posts or wood posts with a minimum cross sectional area of 3.0 sq. in.
3. The fence may be either 40" high orange safety fence, 40" plastic web fencing or any other material as approved by the arborist or landscape architect.

# BEST MANAGEMENT PRACTICES



# 3

# VEHICLE TRACKING AND DUST CONTROL

## IN THIS CHAPTER:

- 3.1 Stabilized Construction Access
- 3.2 Stabilized Construction Roadway
- 3.3 Tire Wash
- 3.4 Street Cleaning
- 3.5 Dust Control



## 3.1 STABILIZED CONSTRUCTION ACCESS

### DESCRIPTION

Stabilized construction access is required to minimize the tracking of soils and sediment from vehicles leaving the construction site. Installation of a rock pad or a construction mud mat at the site's exit/entrance should be used to protect streets and public rights-of-ways. Construction mud mats are comparatively easier to install and remove, and may best fit smaller more urban sites, due to space constraints.

### GUIDELINES

- Install the construction entrance after fencing off “no disturbance” areas and establishing perimeter controls.
- Design mats and rock pads to support the heaviest and widest equipment entering the project site.
- Anchor construction mud mats to the adjacent surface to ensure stable placement.
- Grade the construction exit/entrance to prevent runoff from leaving the site.
- Direct all runoff from the access through a sediment-trapping device prior to discharge.

### MAINTENANCE

Inspect the construction access points daily. If clogged with sediment and debris, clean or replace the rock or mats. Maintenance also includes the cleaning and repair of any structures used to trap sediment.

All materials spilled, dropped, washed or tracked from vehicles onto roadways or into the stormwater collection system shall be removed or cleaned up immediately, and no later than the end of the work day. Applying water to the roadway before sweeping or vacuuming may help loosen sediment, provided that discharge to the stormwater collection system does not occur.



The entrance to this construction site is unstabilized, and will promote dirt tracking.



A gravel construction access is properly installed at the site entrance.



## 3.2 STABILIZED CONSTRUCTION ROADWAY

### DESCRIPTION

Efficient construction road stabilization not only reduces onsite erosion, but can help to avoid instances of immobilized machinery and delivery vehicles, and generally improve site efficiency and working conditions during adverse weather.

### APPLICABILITY

Stabilization of construction roads should occur under the following conditions:

- During wet weather
- During activities that create dust
- When adjacent to water bodies
- When soils are easily erodible
- Where phased construction will cause roads to be placed in and out of service

### GUIDELINES

- Access roads, driveways, subdivision roads, parking areas and other on-site vehicle transportation routes should be stabilized immediately after grading.
- A temporary gravel roadway should be considered during the rainy season and on slopes greater than five percent.
- Roadway slope should not exceed fifteen percent without an alternate surface material. Design stabilized access to support heavy vehicle and equipment use.
- The temporary roadway must be removed, restored and permanently stabilized when construction is complete.

### MAINTENANCE AND INSPECTION

Periodically apply additional aggregate or base material on gravel roads. If using a soil based construction road, apply water at a minimum of three times per day during the dry season for dust control, or as indicated from site traffic. Increase water application according to site traffic.



The contractors properly installed a stabilized construction roadway.



The entrance to this site requires a stabilized roadway.

## 3.3 TIRE WASH

### DESCRIPTION

Tire wash facilities should be located at construction access points to remove sediment from tires and undercarriages, and prevent sediment from being transported onto roadways. The wash water should be discharged to a settling basin or dewatering device prior to leaving the site.

### GUIDELINES

- Incorporate tire wash facilities with a stabilized construction access. There should be separate drive-out space for the tire wash.
- Construct tire wash facilities on level ground when possible, or on a pad of coarse aggregate. A geotextile fabric should be placed below the aggregate.
- Wash racks should be designed and constructed to support anticipated traffic loads.
- Use a drainage ditch to convey the runoff from the wash area to a sediment trapping device. The drainage ditch should be of sufficient grade, width and depth to carry the runoff.
- Direct all traffic leaving the site with mud-caked tires and/or undercarriages use the wash facility.
- Barricades may be installed to collect, control, and hold wash water, especially over asphalt and concrete surfaces.

### MAINTENANCE AND INSPECTION

Inspect the tire wash area daily. Remove trapped sediment on vehicles to ensure it does not travel offsite, and enter the storm drain system.

### SIGNS OF FAILURE:

SYMPTOMS	CAUSES	SOLUTIONS
<ul style="list-style-type: none"> <li>• Mud stays on tires</li> </ul>	<ul style="list-style-type: none"> <li>• Sediment exceeds 1/3 of wash facility capacity</li> <li>• Reused turbid water</li> <li>• Insufficient water spray intensity and/or volume available</li> <li>• Insufficient water contact time</li> </ul>	<ul style="list-style-type: none"> <li>• Remove buildup in wash area</li> <li>• Replace water used in facility. Appropriately dispose of removed materials</li> <li>• Increase water pressure</li> <li>• Clean water feed lines/spray heads</li> <li>• Adjust site exit procedures to allow for soak time in wash area.</li> <li>• Add a second tire wash</li> <li>• Add a grate to vibrate sediment off of tires</li> </ul>



Construction area without a tire wash.



Effects of tire wash removal.

## 3.4 STREET CLEANING

### DESCRIPTION

Street sweeping and vacuuming may be used to remove tracked soils, sand and other debris from public streets and paved areas.

### GUIDELINES

- Streets should be cleaned with a broom.
- The site manager is responsible for cleaning construction vehicles leaving the site on a daily basis.
- Adjacent street frontages should be swept at least once a day to remove silt and other construction related debris.
- Dispose of sweeper wastes at an approved dump-site.



Site violations: unprotected inlet, tracking mud and concrete waste.



Proper street cleaning.



The polluted waste within street needs to be vacuumed and removed.



A street cleaning truck headed to a construction site.



## 3.5 DUST CONTROL

### DESCRIPTION

Dust control reduces surface activities and air movement that cause dust to be generated from disturbed soil areas. These practices consist of applying water or commercial stabilizers to prevent or minimize generation of dust.

San Francisco enforces dust control regulations:

- San Francisco Department of Public Health implements Article 31 of the Health Code through review, approval and monitoring of dust control plans for over one acre construction sites.
- Contact the SFPUC to determine the extent of review and approval required for your project.

### GUIDELINES

#### Administrative Controls

These methods involve preventative measures such as enacting traffic restrictions/speed limits and reducing work activities when wind speeds exceed 15 miles per hour.

#### Structural Controls

The following examples are methods of dust control to be used during work site operations:

- Stabilize storage, vehicle movement, and parking areas by installing gravel over geotextile fabric.
- Install or maintain vegetative or structural barriers.
- Sweep or vacuum paved surfaces to remove tracked soil.
- Apply mulch to exposed soil.
- Use tarps to cover stockpiles.
- Load trucks carrying excavated material so that the material does not extend above the walls or back of the truck bed. Wet the surface of each load and tightly cover before the haul truck leaves the loading area.



An exposed stockpile is susceptible to dust generation.



Water is applied to exposed soil and stockpiles to prevent dust generation.

## 3.5 DUST CONTROL

### WATER SPRAYING

Mist the immediate excavation area with a water spray to prevent airborne dust particles. During dust generation activities, perform continuous water spraying. While spraying, be sure to prevent ponding and/or generation of runoff that could potentially reach storm drains inlets.

### COMMERCIAL STABILIZERS

Chemical based stabilizers may be used on site as an alternative to water. Stabilizers include tackifier mixtures and other binding agents. Stabilizers typically come in a concentrated form and are applied through a surface spray either by a water truck or a handheld sprayer.



In order to reduce the dust generated by delivery trucks, water should be applied to all disturbed areas.



# BEST MANAGEMENT PRACTICES





# EROSION AND SEDIMENT CONTROL

## IN THIS CHAPTER:

- |     |                                 |      |                                  |
|-----|---------------------------------|------|----------------------------------|
| 4.1 | Soil Preparation and Roughening | 4.10 | Slope Drains                     |
| 4.2 | Rolled Erosion Control Products | 4.11 | Check Dams                       |
| 4.3 | Hydraulic Mulch                 | 4.12 | Inlet and Catch Basin Protection |
| 4.4 | Straw Mulch                     | 4.13 | Fiber Rolls                      |
| 4.5 | Wood Mulching                   | 4.14 | Silt Fence                       |
| 4.6 | Hydroseeding                    | 4.15 | Gravel Berm                      |
| 4.7 | Soil Binders                    | 4.16 | Sediment Trap                    |
| 4.8 | Sodding                         | 4.17 | Active Treatment Systems (ATS)   |
| 4.9 | Diversion Structures            |      |                                  |



## 4.1 SOIL PREPARATION AND ROUGHENING

### DESCRIPTION

Soil preparation and roughening involves the assessment and preparation of surface soils for BMP installation. This preparation should include soil testing and recommendations for correcting compacted soils. Roughening surface soils by mechanical methods may be required to prepare soil for additional BMPs or break up overland flow. Soil preparation can also involve tilling topsoil to prepare a seed bed and incorporating soil amendments to enhance vegetative establishment.

### APPLICABILITY

**Soil preparation:** Soil preparation is essential for proper vegetative establishment, and may be combined with any soil stabilization method, including rolled erosion control products or sod.

**Compaction:** Compaction is a result of construction activity and repairing compacted soils is essential to effective erosion control. Further correcting compacted soil supports successful final stabilization, and vegetative restoration.

**Roughening:** Soil roughening is generally referred to as track walking a slope, where treads from heavy equipment run parallel to the contours of the slope, creating small terraces. Roughening may be performed:

- Along any disturbed slopes;
- In combination with hydraulically applied stabilization methods, compost blankets or mulch;
- As a complementary process for controlling erosion on a site; and
- In combination with perimeter controls, additional erosion control measures, grade breaks, and vegetative establishment for maximum effectiveness.



Soil roughening was used on this construction area to prepare for vegetative establishment.

## 4.1 SOIL PREPARATION AND ROUGHENING

### GUIDELINES

**Soil Preparation:** Where appropriate or feasible, soil should be scarified to eliminate crust, improve air and water infiltration, and support vegetative establishment

**Compaction:** Correct compacted soils according to the recommendations of the project's landscape architect, soil engineer, or landscape contractor.

**Cut Slope Roughening:** Stair-step grade or groove the cut slopes that are steeper than 3:1.

- Use stair-step grading on any erodible material soft enough to be ripped with a bulldozer.

### Fill Slope Roughening:

- Place on fill slopes with a gradient steeper than 3:1 in lifts not to exceed 8 inches and make sure each lift is properly compacted.
- Place and compact main body of fill in accordance with the geotechnical or soils engineer's recommendations.
- Use grooving or tracking to roughen the face of the slopes.
- Do not blade or scrape the final slope face, unless a rolled erosion control product (RECP) BMP is specified. These products should only be installed on smooth slope faces.

### Roughening for Slopes to be Mowed:

- Slopes which require mowing activities should not be steeper than 3:1.
- Roughen these areas with shallow grooves by track walking, scarifying, sheepsfoot rolling, or imprinting.
- Make grooves close together (between land 10 inches), and not less than 1 inch deep, and perpendicular to the direction of runoff.



Heavy machinery was used to track walk these soils.



## 4.1 SOIL PREPARATION AND ROUGHENING

### Roughening with Tracked Machinery:

- Limit roughening with tracked machinery to soils with a sandy textural component to avoid undue compaction of the soil surface.
- Operate tracked machinery up and down the slope to leave horizontal depressions in the soil. Do not back-blade during the final grading operation.

### MAINTENANCE AND INSPECTION

Check the seeded slopes for signs of erosion such as rills and gullies. Fill these areas slightly above the original grade, then reseed and mulch as soon as possible.



Soil roughening can be used as a complementary process for controlling erosion.

## 4.2 ROLLED EROSION CONTROL PRODUCTS

### DESCRIPTION

Rolled erosion control products (RECPs) are used in combination with topsoiling, soil amendments and vegetative growth to form surfaces that help to protect disturbed soil areas from the erosive forces of water, wind or the scouring forces of channelized flow. RECPs involve the placement of geotextiles, plastic covers, and erosion control blankets and mats to stabilize disturbed soil areas, and protect soil from erosion by wind or water. RECPs can be used as stand-alone soil stabilization BMPs or in conjunction with re-vegetation. They can also be used to reinforce mulch.

### GUIDELINES

When choosing a product appropriate for the specific site condition consider:

- Effectiveness of reducing erosion, flow velocity and runoff;
- Compatibility with native plants, wildlife, moisture retention;
- Durability, longevity and projected maintenance; and
- Plastic products are not allowed in areas that protect wildlife such as the San Francisco Garter Snake and the California Red-legged Frog.



Jute netting was placed along these slopes to prevent erosion prior to the establishment of vegetation.

TYPE	COST/YARD <sup>2</sup> (INSTALLED)*
Geotextiles	\$9.30
Netting (Biodegradeable)	\$7.23
Erosion Control Blankets	\$5.16
Mats	\$7.70

\*These are estimates of construction cost per acre. Costs vary greatly due to size of area treated, accessibility, slope steepness, location and inflation.

Source: California Department of Transportation. 2013. Caltrans Erosion Control Tool Box. [www.dot.ca.gov/hq/LandArch/ec/index.html](http://www.dot.ca.gov/hq/LandArch/ec/index.html).

## 4.2 ROLLED EROSION CONTROL PRODUCTS

### Types of RECPs

**Geotextiles:** Geotextiles can be used for drainage control and slope stabilization. Geotextiles are a woven non-biodegradable polypropylene fabric. Woven geotextiles are used on disturbed soil areas where durable materials are needed to endure abrasive forces through the life of a project.

**Plastic Covers:** Plastic covers can be used for drainage control and slope stabilization. Plastic covers are used on stockpiles of soil and/or mulch, and on very small disturbed soil areas that require immediate attention for a short period of time.

**Netting:** Netting can be used to secure loose mulches.

**Erosion Control Blankets:** Erosion control blankets can be biodegradable and/or photodegradable. Biodegradable and photodegradable blankets are composed of biodegradable fibers such as curled wood fiber, wood, jute, straw, coconut, or a combination of straw and coconut fibers.

**Mats:** Mats or Turf Reinforcement Mats (TRMs) act as a three-dimensional matrix that is thick and porous enough to incorporate soil. TRMs are designed to be a more of a permanent form of soil stabilization, but are also suitable for temporary stabilization and high-velocity concentrated flow situations.

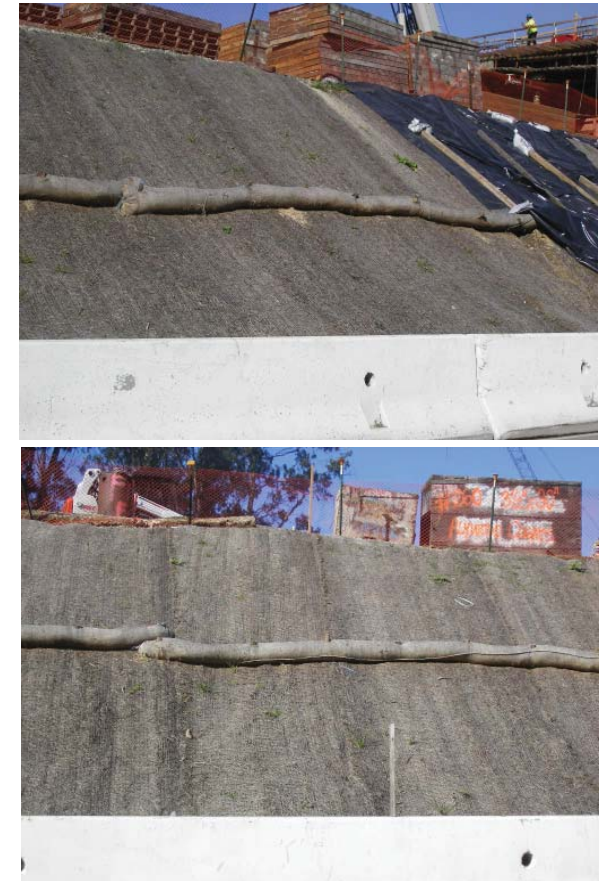

Jute netting with fiber rolls are installed to stabilize this steep slope along the roadway.



## 4.2 ROLLED EROSION CONTROL PRODUCTS

### INSTALLATION

- Remove all rocks, clods, vegetation or other obstructions and grade to allow the blanket or mat to come into consistent contact with the soil surface. Improper installation allows rain runoff to flow under the blanket.
- Ensure RECPs are adequately overlapped and securely anchored to resist the effects of wind and water.
- If the area is to be mowed at a later date, the anchoring staples or stake pins should be driven flush to the soil surface to avoid a potential hazard during the mowing.
- Install in accordance with manufacturer's instructions.

### MAINTENANCE AND INSPECTION

RECPs should be inspected periodically and after rainstorms for signs of erosion or undermining. Failures should be corrected immediately. Material should be reinstalled following any tears or separations, and the slope or channel should be backfilled and stabilized.



Erosion control blankets are being used to stabilize disturbed soil area.



## 4.3 HYDRAULIC MULCH

### DESCRIPTION

Hydraulic mulch is a mixture of wood mulch, and water (with or without combinations of stabilizing emulsion, recycled paper, and/or other organic fibers). This slurry is applied to disturbed soil areas using hydro-mulching equipment to temporarily stabilize the soil, and reduce erosion caused by wind and water. Common types of hydraulic mulches include organic fiber mulch and hydraulic matrix (this includes mulches with binders added and products that are all inclusive and cover several application specification). These products should be specified by the qualified SWPPP developer and/or landscape architect.

### GUIDELINES

- Roughen the soil prior to application. Refer to Soil Roughening on pg. 36.
- To be effective, hydraulic matrices require 24 hours to dry before rainfall occurs.
- Avoid mulch over spray onto roads, sidewalks, drainage channels, existing vegetation.
- Follow project specifications for application. Rates vary depending on slope, material type soils.

All mulch products should be applied during a dry period, with a minimum of 24-hour set time from application to first rain event for all hydraulic products.



These disturbed soils were stabilized using a bonded fiber matrix.

## 4.3 HYDRAULIC MULCH

### MAINTENANCE

Inspect BMPs prior to forecasted rain, daily during extended rain events, after rain events, weekly during the rainy season, and at two-week intervals during the non-rainy season. Maintain an unbroken, temporary mulched ground cover throughout the period of construction when the soils are not being reworked.



A construction worker is applying a bonded fiber matrix to disturbed soil area.

## 4.4 STRAW MULCH

### DESCRIPTION

Straw mulch consists of placing a uniform layer of straw and incorporating it into the soil with a studded roller or anchoring it with a tackifier. Straw mulch is used as a temporary surface cover for soil stabilization on sites until soils can be prepared for re-vegetation.

### GUIDELINES

- Straw should be derived from certified weed free wheat, rice or barley.
- Straw mulch should be evenly distributed on the soil surface. Manufacturer suggested application rates should be followed so that mulch covers the soil in a uniform layer without any visible bare spots.
- Straw mulch may be spread with a straw blower or by hand. Be sure that air born dust is kept to a minimum. Manual application is time and labor intensive, and tends to result in consistent thickness. California regulations require that all straw blowing equipment meet air quality standards that diminish dust issues during application.
- Typical application is 4,000 lbs per acre. If applied with seed, the seed should be applied hydraulically with a 500 lb per acre trace material (paper or combination mulch), straw applied, then a binding material at a minimum of 250 lbs per acre or as specified.

### MAINTENANCE AND INSPECTION

Inspect straw mulch prior to and after rain events. Repair any damaged areas and re-mulch exposed areas of soil.



Straw mulch is applied to help vegetation establishment.

TYPE	COST/YARD <sup>2</sup> (INSTALLED) <sup>***</sup>	SEDIMENT REDUCTION (%)
Bonded Fiber Matrix	\$1.158*	90%
Straw (Hydraulically applied)	\$0.52**	90%
Wood	\$0.19**	45%

\*Hydromulching cost varies with the type of mulch selected, the application method, water availability and area size.

\*\*Mulch application methods (by hand or by commercial blowers) can effect costs.

\*\*\*These are very rough estimates of construction cost per acre. Costs vary greatly due to size of area treated, accessibility, slope steepness, location and inflation.

**Source:** North Carolina State University 2008. SoilFacts: Mulch Options for Erosion Control on Construction Sites. [www.soil.ncsu.edu/publications/Soilfacts/AG439-67W.pdf](http://www.soil.ncsu.edu/publications/Soilfacts/AG439-67W.pdf)

California Department of Transportation. 2013. Caltrans Erosion Control Tool Box. [www.dot.ca.gov/hq/LandArch/ec/index.html](http://www.dot.ca.gov/hq/LandArch/ec/index.html)



## 4.5 WOOD MULCHING

### DESCRIPTION

This BMP consists of applying a mixture of shredded wood mulch, bark, or compost to bare soil to reduce runoff, increase infiltration, and reduce erosion due to rainfall impact. Wood mulch may provide temporary or permanent ground cover for landscaping projects.

### GUIDELINES

- Select wood mulch products appropriate for the application and site conditions.
- Application preparation involves removal of existing vegetation, filling and compaction of holes or voids, and scarifying the embankment. Depending upon the product, wood mulch should be placed at a depth of two to three inches.
- Inspection and maintenance involves monitoring to assure the mulch lasts an adequate time to achieve erosion control objectives. Inspect areas before and after rains events. Repair any damaged areas by adding more wood mulch.



Wood mulch is applied to landscaping to reduce erosion and to help with vegetation establishment.



## 4.6 HYDROSEEDING

### DESCRIPTION

Hydroseeding consists of applying a mixture of fiber, seed, fertilizer, and stabilizing liquid mixture with hydro mulch equipment to protect exposed soils from erosion by water and wind.

### APPLICABILITY

Hydroseeding may be performed on:

- Disturbed areas requiring temporary protection until permanent stabilization is established.
- Disturbed areas that will be re-disturbed following an extended period (6 to 12 months) of inactivity
- Cleared and graded areas exposed to seasonal rains or temporary irrigation.
- Areas not subject to heavy wear by construction equipment or high traffic.

### INSTALLATION

Where appropriate, soil should be prepared (See Soil Preparation BMP on pg. 36).

- Hydraulic seed can be applied using a multiple step or one step process.
- In a multiple step process, hydraulic seed is applied first, followed by mulch or a RECP.

- In the one step process, hydraulic seed is applied with hydraulic mulch in a hydraulic matrix. When the one step process is used to apply the mixture of fiber, seed, etc., the seed rate should be increased to compensate for all seeds not having direct contact with the soil, or as specified by the landscape architect.
- All hydraulically seeded areas should have mulch, or alternate erosion control cover to keep seeds in place and to moderate soil moisture and temperature until the seeds germinate and grow.

### MAINTENANCE AND INSPECTION

Regularly inspect the area to ensure seed germination and vegetation establishment. Where seeds fail to germinate, the area must be re-seeded, fertilized, and mulched within the planting season, using not less than half the original application rates. Physical inspection should be performed following rain events to observe gully and displaced mulch.



Hydroseed was applied to the hillside to provide stabilization.



Do not apply hydroseed to areas receiving heavy vehicle traffic.

## 4.7 SOIL BINDERS

### DESCRIPTION

Soil binders are stabilizing emulsions applied directly to the surface of disturbed soil areas or used as the stabilizer in hydraulic mulch, hydroseeding, and/or on straw mulch. Soil binders applied directly to the surface temporarily reduce erosion caused by water and wind by penetrating the top soil and binding the soil particles together.

### GUIDELINES

Soil binders can be effective for periods of 3 months or longer, depending on the requirement of the specifications. Soil binders are categorized as: short-lived plant based materials, long-lived plant based materials, polymeric emulsion blends (acrylic polymers), and cementitious-based binders.

The less durable stabilizing emulsions are called tackifiers. Short lived plant based materials, highly diluted polymeric emulsions and cementitious binders are tackifiers. They are applied directly to the soil surface or are used as the stabilizing emulsion in hydraulic and straw mulches for disturbed soil areas that require short term stabilization.

The more durable stabilizing emulsions are heavy duty soil binders. Heavy duty soil binders are applied directly to the soil surface or used as the stabilizing emulsion in hydraulic and straw mulches for disturbed soil areas that require long term stabilization. Long lived plant based materials, less diluted polymeric emulsions and cementitious binders are considered heavy duty soil binders. Soil binders are also used to stabilize temporary roads during construction. Use only those binders specified in the plans, for each application.



A hydraulic mulch with binder is applied to disturbed soil areas.

## 4.7 SOIL BINDERS

### INSTALLATION

After selecting an appropriate soil binder, the untreated soil surface must be prepared before applying the soil binder. The untreated soil surface must contain sufficient moisture to assist the agent in achieving uniform distribution. In general, the following steps should be followed:

- Follow manufacturer's written recommendations for application rates, pre-wetting of application area, and cleaning of equipment after use.
- Prior to application, roughen embankment and fill areas.
- Consider the drying time for the selected soil binder and apply with sufficient time before anticipated rainfall. Soil binders should not be applied during or immediately before rainfall.
- Avoid over spray onto roads, sidewalks, drainage channels, sound walls, existing vegetation, etc.
- Soil binders should not be applied to frozen soil, areas with standing water, under freezing or rainy conditions, or when the temperature is below 40°F during the curing period.
- More than one treatment is often necessary, although the second treatment may be diluted or have a lower application rate.

- Generally, soil binders require a minimum curing time of 24 hours before they are fully effective. Refer to manufacturer's instructions for specific cure time.

### MAINTENANCE AND INSPECTION

Inspect BMPs prior to forecasted and rain, daily during extended rain events, after rain events, weekly during the rainy season, and at two-week intervals during the non-rainy season. Repair eroded areas and reapply BMP as soon as possible. Minimize damage to stabilized areas while making repairs. The binder will be reapplied as needed to maintain effectiveness.



A hydraulic mulch with binder is applied to a disturbed soil area.

## 4.7 SOIL BINDERS

CATEGORY	TYPE	DESCRIPTION
Plant-Based Material (Short Lived)	Guar	Biodegradable, natural galactomannan-based hydrocolloid, treated with dispersing agents for easy field mixing.
	Starch	Non-ionic, cold-water soluble (pre-gelatinized) granular corn-starch.
	Psyllium	Finely ground muciloid coating of plantago seeds that is applied as a dry powder or in a wet slurry to the surface of the soil.
Plant-Based Material (Long Lived)	Pitch & Rosin Emulsion	A non-ionic pitch and rosin emulsion that has a minimum solids content of 48 percent. The rosin shall be a minimum of 26 percent of the total solids content. The soil stabilizer shall be a non-corrosive, water-dilutable emulsion that cures to water-insoluble binding and cementing agent upon application.
Polymeric Emulsion Blends	Liquid Polymers of Methacrylates & Acrylates	A tackifier/sealer that is liquid polymer of methacrylates and acrylates. It is an aqueous 100 percent acrylic emulsion blend of 40 percent solids by volume that is free from styrene, acetate, vinyl, ethoxylated surfactant, and/or silicates.
	Copolymers of Sodium Acrylates & Acrylamides	Non-toxic, dry powders that are comprised of copolymers of sodium acrylate and acrylamide.
	Poly-Acrylamide & Copolymers of Acrylamides	Linear copolymer polyacrylamide is packages as a dry-flowable solid.
	Hydro-Colloid Polymers	Various combinations of dry-flowable poly-acrylamides, copolymers, and hydrocolloid polymers
	Acrylic Copolymers & Polymers	Liquid or solid polymer or copolymer with an acrylic base that contains a minimum of 55 percent solids. The polymeric compound shall be handled and mixed in a manner that will not cause foaming or shall contain an antifoaming agent. Polymeric soil stabilizer shall be readily miscible in water, non-injurious to seed or animal life, and non-flammable. It shall not re-emulsify when cured.
Cementitious- Based Binders	Gypsum	A formulated gypsum-based product that readily mixes with water mulch to form a thin protective crust on the soil surface. It is composed of highly pure gypsum that is ground, calcined, and processed into calcium sulfate hemihydrate with a minimum purity of 89 percent.



## 4.8 SODDING

### DESCRIPTION

Sodding is a permanent erosion control practice and involves laying a continuous cover of grass sod on exposed soils. Sodding can stabilize disturbed areas and reduce the velocity of stormwater runoff. This BMP can provide immediate vegetative cover for critical areas and stabilize areas that cannot be readily vegetated by seed. It also can stabilize channels or swales that convey concentrated flows, and reduce flow velocities.



Sod is installed to provide permanent vegetation and erosion control.

### INSTALLATION

- In the area to be sodded, clear all trash, debris, roots, branches, stones and clods larger than 2 inches in diameter.
- If a soil test determines the need, prepare the soil, and add lime and fertilizer.
- Lay strips of sod:
  - Beginning at the lowest area to be sodded.
  - Perpendicular to the direction of water flow, and stagger it in a brick-like pattern.
- On slopes steeper than 30%, staple the corners and middle of each strip firmly. Place jute or plastic netting over the sod to protect against washout during establishment.
- Roll the sodded area and irrigate.
- Ensure that sod is harvested, delivered, and installed within a period of 36 hours. If it is not transplanted within this period, inspect and approve the sod before its installation.

### MAINTENANCE AND INSPECTION

When mowing, do not remove more than one-third of the shoot. Maintain a grass height between 2 and 3 inches. After the first growing season, determine if additional fertilization or liming is needed. Permanent, fine turf areas require yearly maintenance fertilization. If the grass is unhealthy, the cause shall be determined and appropriate action taken to re-establish a healthy ground cover.

## 4.9 DIVERSION STRUCTURES

### DESCRIPTION

Diversion structures are structures that intercept, divert, and convey surface runoff around or through the project site in a non-erosive manner.

### GUIDELINES

Dikes and drainage swales are suitable for use, individually or together. When properly placed and maintained, dikes used as temporary diversions can control the velocity and direction of stormwater runoff. Used by themselves, they do not have any sediment removal capability. They must be used with an appropriate sediment-trapping device at the outfall of the diversion channel. It may be necessary to use other erosion and sediment control measures such as check dams, plastic sheeting or blankets to prevent scour and erosion in these swales, dikes and ditches. In some cases, the swale may need to be constructed of concrete or rock. Diversion structures may be used:

- To convey surface runoff down sloping land;
- Along paved surfaces to intercept runoff;
- Along the top of slopes to divert surface flow from slopes;
- To divert and direct runoff towards stabilized drainage systems; and
- Below steep grades where runoff begins to concentrate.

### INSTALLATION

- A combination dike and swale is easily constructed by a single pass of a bulldozer or grader, and compacted by a second pass of the tracks or wheels over the ridge.
- Diversion structures should be installed when the site is initially graded and remain in place until post construction BMPs are installed and the slopes are stabilized.
- Temporary diversion dikes should not adversely impact adjacent properties, and should not be used in areas with slopes steeper than 10%.
- Provide stabilized outlets.
- Divert sediment laden runoff into sediment traps.

### MAINTENANCE AND INSPECTION

Check channels, embankments and ditch beds for erosion, washout and accumulation of sediment and debris. Remove sediment accumulation and debris, and repair or replace lost riprap, linings or soil stabilization, as needed.



A temporary diversion structure was built upstream from a steep slope. It prevents runoff from flowing down the slope and causing hillside erosion.



## 4.10 SLOPE DRAINS

### DESCRIPTION

Slope drains convey water down a slope into a stabilized water trapping device or area. Slope drains are used with lined ditches atop a fill bank to convey surface flow away from incline areas and to protect exposed slopes.

### GUIDELINES

- Install slope drains perpendicular to the slope contour.
- Drain pipes must be securely anchored to the slope, and must be adequately sized to carry the capacity of the design storm and associated forces.
- Compact the soil around and under the slope drain inlet, outlet, and along the length of the pipe. Protect the pipe inlet with filter fabric. Use flared end sections for inlets and discharges for pipes 12 inches in diameter and larger.
- Protect the discharge outlet with riprap or other velocity dissipation devices. For high velocity discharge, integrate concrete into the riprap.

### MAINTENANCE AND INSPECTION

Inspect prior to and after each rain event and twice monthly until the upstream drainage area is stabilized. Inspect outlets for erosion and downstream scour. In the event of scour, reduce the flows into the channel unless other preventative measures can be implemented.



Clean runoff is directed to the storm system through a slope drain. This prevents the runoff from flowing down the steep slope.



## 4.11 CHECK DAMS

### DESCRIPTION

Check dams are small structures placed across a natural or man-made drainage channel to reduce scour and erosion by reducing flow velocity and encouraging sediment deposition. They are typically constructed of gravel rock bags, rip rap or fencing depending on site conditions and material availability.

### GUIDELINES

Check dams are generally used in:

- Small open channels;
- Steep channels where runoff velocities exceed five feet per second;
- Ditches or channels where grass linings are being established; or
- Temporary ditches where short term service does not warrant establishment of erosion resistant linings.

### INSTALLATION

- Install check dams approximately 20 feet from the intake structure and at regular intervals along the channel. Space dams closer together where there is a high potential of erosion (steep grades and/or high flows).
- Embed structure sufficiently in sides and bottom of channel to prevent undercutting.
- The dams should be placed at a height and distance allowing small pools to form behind them but also allowing high velocity runoff (typically a two year storm or larger) to safely flow over them without an increase in upstream flooding or damage to the dam.
- Stabilize channel immediately downstream of check dams to prevent erosion at the toe of the structure.
- If using a prefabricated check dam, follow manufacturer's recommendations and installation instructions.

### MAINTENANCE AND INSPECTION

Perform maintenance as required. Inspect following rainfall events and at least daily during prolonged rainfall. Maintain to provide an adequate sediment holding capacity. Remove debris daily and remove sediment when it accumulates to 1/3 of the dam height.



Plastic check dams are used to reduce runoff velocity and to control erosion and sediment displacement.



Gravel bags are used to form a check dam along the roadway.

## 4.12 INLET AND CATCH BASIN PROTECTION

### DESCRIPTION

Drain inlet and catch basin protection reduces sediment entering the storm drain system carried by runoff from a construction site. Effective storm drain protection allows sediment to settle out of water or filters sediment from the water before it enters the drain inlet. All inlets and basins that are connected to the storm drain system must be protected. Inlet protection is the last line of defense for water quality prior to water entering the drainage system.

There are several types of inlet and catch basin protection measures:

#### Excavation around the perimeter of the inlet/basin

Excavating an area around an inlet creates a settling pool that removes sediments as water is released slowly into the inlet through small holes protected by gravel and filter fabric.

#### Reusable barriers around drain entrances

Erecting a barrier made of plastic filtration fencing around an inlet creates a shield against sediment while allowing water to flow into the drain. This barrier slows runoff while catching soil and other debris at the drain inlet.

### GUIDELINES

#### Excavation around the perimeter of the drop inlet

Install these controls before any soil disturbance in the drainage area. Excavate around drop inlets at least 1 foot deep (2 feet maximum). Side slopes at the edge of the excavation should be no steeper than 2:1. Design the shape of the excavated area such that the dimensions fit the area from which stormwater is expected to drain. Drill or cast one 1 inch diameter hole for each 12 inch of wall length in each side of the inlet at approximately 3 inch above bottom of the excavation. Cover each hole with filter fabric and protect with a minimum of 1 cubic foot of 1/2 – 3/4 inch of clean gravel.

#### Reusable barriers around inlet entrances

Stake the plastic filtration fencing close to the inlet to prevent overflow onto unprotected soils. Stakes should be at least 1.5 feet long for fences that are at least 10 inches tall. Follow manufacturers' guidelines for specific installation instructions.

### MAINTENANCE AND INSPECTION

Check all temporary control measures before and after each storm event. During extended storm events, inspect at least once every 24 hours.

- Remove accumulated sediment from the area around the drop inlet and catch basin when the capacity is reduced by half.
- Remove additional debris from the shallow pools periodically. The weep holes in excavated areas around inlets can become clogged, preventing water from draining out of the pools.
- Clear sediment build around barrier.



Unprotected inlets



Unprotected inlets



Unprotected inlets



Properly protected inlets



Properly protected inlets



Properly protected inlets

## 4.13 FIBER ROLLS

### DESCRIPTION

A fiber roll consists of straw, flax or synthetic fiber that is rolled and bound into a tubular cylinder, and staked or otherwise attached to the ground to prevent movement. These rolls intercept runoff and reduce the flow allowing sediment to settle out. Fiber rolls can also reduce erosion by interrupting the length of a slope. They are not appropriate for use on paved surfaces.

### APPLICABILITY

Fiber rolls can be used:

- Around temporary stockpiles;
- As perimeter control;
- At the top of slopes to intercept sheet flow from flatter areas;
- At the bottom of the slopes;
- Parallel to the contours of the slope;
- To shorten slope length of exposed and erodible slopes along face or at-grade breaks; and
- Perpendicular to the flow lines in ditches and swales.

### GUIDELINES

If more than one fiber roll is placed in a row, the rolls should be overlapped by at least one foot. The diameter of the stake should be approximately 1" for ease of driving through the roll. Refer to manufacturers' installation instructions for proper installation.

**Sloped Ground:** On slopes, install fiber rolls along the contour with a slight downward angle at the end of each row to prevent ponding at the midsection.

Turn the ends of each fiber roll upslope to prevent runoff from flowing around the roll.

Install the rolls in shallow trenches (width equal to diameter of roll) 3 to 5 inches deep for soft, loamy soils and 2 to 3 inches deep for hard, rocky soils.

Rolls must be staked down at an interval of every four feet to be effective. Biodegradable wood stakes or willow cuttings are recommended. Drive the stakes through the middle of the roll and deep enough into the ground to anchor it in place. About 3 to 5 inches of the stake should stick out above the roll. A 24-inch stake is recommended for use on soft, loamy soils. An 18-inch stake is recommended for use on hard, rocky soils.

The table contains recommended spacing between fiber rolls:

PERCENT SLOPE	MAX SPACING BETWEEN ROLLS (CLOSER IS MORE EFFECTIVE)
0-25%	20 feet
25 - 50%	15 feet



Fiber rolls are installed along a hillside to reduce erosion.



Plastic mesh fencing is installed parallel to the contours along the slope.



## 4.13 FIBER ROLLS

**Level Ground:** Typically, the rolls are installed along sidewalks, on the bare lot side, to keep sediment from washing onto sidewalks and streets and into gutters and storm drains. For installations along sidewalks and behind street curbs, it might not be necessary to stake the fiber rolls, but trenches must still be dug. Fiber rolls placed around storm drains and inlets must be staked into the ground.

### MAINTENANCE AND INSPECTION

The maintenance requirements of fiber rolls are minimal, but regular inspection is recommended to ensure that the rolls remain firmly anchored in place and are not excessively crushed or damaged by equipment traffic.

- Inspect fiber rolls before and after rain events, and at least daily during prolonged rainfall.
- Repair or replace split, torn, unraveled, or slumping fiber rolls. Fiber rolls are typically left in place on slopes after construction is complete as part of site stabilization. If they are removed, collect and dispose of the accumulated sediment.
- After removal, fill and compact holes, trenches, depressions or any other ground disturbance to blend with the surrounding landscape.

### LIMITATIONS

- Difficult to move once saturated. Some saturated fiber rolls may require a crane or other machinery to remove from site.
- If not properly staked and trenched in, fiber rolls could be displaced by high flows.
- Fiber rolls have a very limited sediment capture zone.
- Fiber rolls should not be used on slopes subject to creep, slumping, or landslide. Use RECP with stronger soil stabilizing properties.

### ALTERNATIVES

Polyethylene sediment-filtration fencing can be used as a substitute for the traditional fiber roll. This reusable and recyclable product is used for slope protection and stabilization. It slows the velocity and spreads the flow of runoff. The filter removes pollutants and sediment from the runoff. These products are easy to install, highly resistant to vehicle and foot traffic, and are lightweight.



Fiber rolls are properly installed around a stockpile.



Remove or by pass all obstructions prior to placing fiber roll. Do not install the roll over the obstruction.

# 4.13 FIBER ROLLS

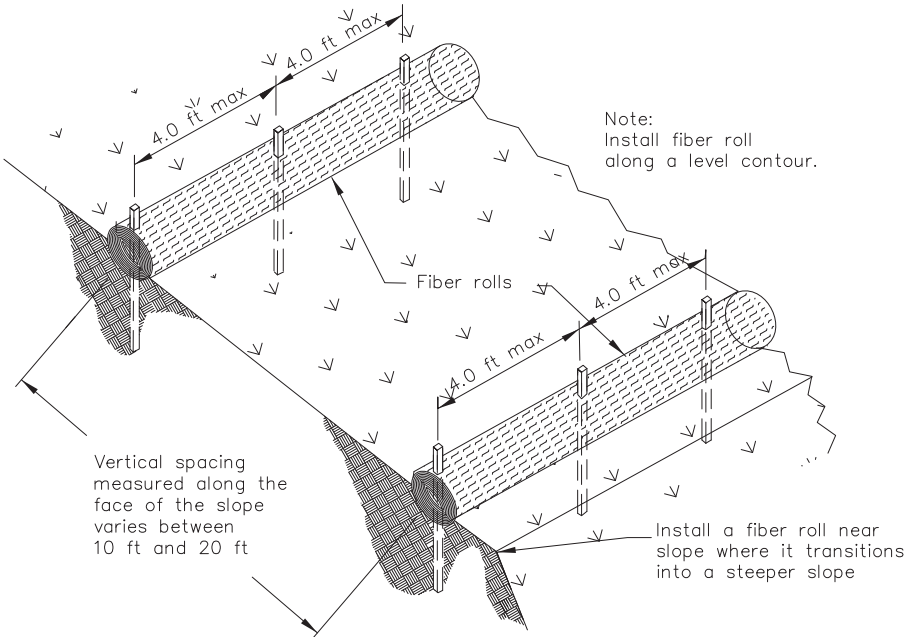

TYPICAL FIBER ROLL INSTALLATION  
N.T.S.

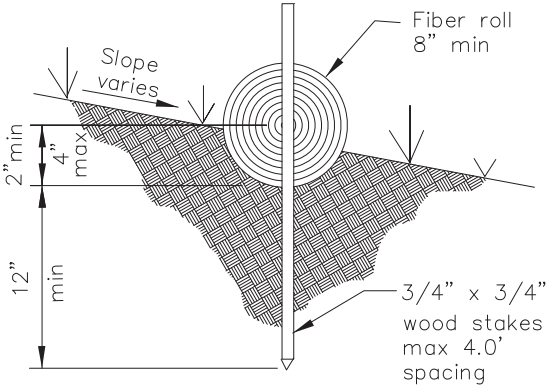

ENTRENCHMENT DETAIL  
N.T.S.

## 4.14 SILT FENCE

### DESCRIPTION

A silt fence is a temporary linear barrier that captures sediment by retaining runoff, allowing the sediment to settle out. The fences are typically made of a non-woven geotextile, and come in standard or heavy-duty strength.

### APPLICABILITY

Silt fences can be used:

- Along the contour of a slope;
- Below the toe or down slope of exposed or erodible slopes;
- Below other cleared areas; and
- In areas where sheet flow occurs.

### GUIDELINES

The fence should be installed on a level contour. The ends of the fence should be angled up stream to prevent sedimentary laden water from running around the ends.

- Excavate a 6 inch wide by 6 inch deep trench along the line of the fence. Backfill the trench with native material.
- The bottom 12 inches of fence should be securely placed into the ground.
- Stake posts a maximum of 6 feet apart, and securely place posts into the ground a minimum of 18 inches.
- Where additional structural support is needed, fasten a plastic or wire mesh support fence to standard strength silt fence.



This silt fence is not properly installed and sized causing failure.



Silt fence is attached to construction fencing to prevent sediment from leaving the site.



## 4.14 SILT FENCE

### MAINTENANCE AND INSPECTION

Silt fences can be maintenance intensive. Perform inspections before and after every rain event, and every 24 hours during extended rain events. Also, weekly inspections throughout the rainy season are recommended. Remove sediment deposits when they reach 1/3 of the fabric height. All torn or decomposed fencing should be replaced. Do not allow water or sediment depth to exceed 1.5 feet at any point. The fence should remain in place until the disturbed area is permanently stabilized.

### ALTERNATIVES

Temporary high density polyethylene sediment-filtration fencing can be used as a substitute for the traditional silt fence. This reusable product which is made from recycled materials, is used for slope and perimeter protection. It slows the velocity and spreads the flow of runoff while handling larger floods and pressures. The filter removes pollutants and sediment from the runoff. These products are easy to install, durable, and are lightweight.



Extend the silt fence to the top of the perimeter fencing. This provides wind control and site security.



Silt fence is properly installed along the slope to intercept sheet flow.

## 4.15 GRAVEL BERM

### DESCRIPTION

A gravel berm consists of a row of gravel bags installed end to end to form a barrier across a slope to intercept runoff, reduce runoff velocity and release runoff as sheet flow after providing some sediment removal.

### APPLICABILITY

Berms are used as linear sediment control measures. Suitable locations include:

- At the top, toe, face and grade break of slopes;
- Along a roadway to keep sediment off paved areas;
- At the perimeter of sites; and
- As sediment traps at drainage outlets.

### INSTALLATION

A gravel bag berm intercepts and slows sheet flow runoff, causing temporary ponding. This provides a stagnant area for sediment to settle. The gravel is porous, which allows the ponded runoff to flow slowly through the bags, releasing the runoff as sheet flow.

- Locate gravel bag berms on level contours
- Locate bags at the following intervals when placed along slopes:
  - 4:1 or flatter slope: place bags at 20 ft intervals
  - 4:1 to 2:1 slope: place bags at 15 ft intervals
  - 2:1 or greater: place bags at maximum of 10 ft intervals



Inspect and maintain all BMP's to ensure that they perform well, and do not fail like this gravel bag berm.



A gravel berm acts a sediment trap near a catch basin.



## 4.15 GRAVEL BERM

---

### MAINTENANCE AND INSPECTION

This BMP is labor and maintenance intensive. Inspect gravel bags before and after rain events, and weekly during the rainy season. Repair and replace broken or ripped bags, and remove accumulated sediment when it reaches 1/3 the height of the bag.



A gravel berm is being used to slow the runoff and filter out sediment.



## 4.16 SEDIMENT TRAP

### DESCRIPTION

This is a temporary settling area formed by shallow excavation, perimeter construction of an earthen embankment or an embankment constructed across a waterway or low drainage area. It includes a controlled release structure like a sump pump or overflow structure.

The sediment trap is used as a pretreatment measure for entry of the runoff into the storm drain system or natural waterway. This BMP allows sediment to settle out of runoff prior to the discharge of the water into the local storm drainage system or natural waterway.

### GUIDELINES

The trap should be excavated where breach of the perimeter would not pose a risk to life or property. Access should be provided for maintenance including sediment removal.

The length of the trap should be more than three times the width. Traps with levees greater than five feet in height should be designed by a professional civil engineer. The trap inlet should be located as far as possible from the outlet structure in order to allow maximum sediment settlement. Traps may require protective fencing to ensure safety.

### MAINTENANCE AND INSPECTION

Traps should be inspected before and after every rain event, weekly during the rainy season, and at 24-hour intervals during extended storms. Check inlet and outlet structures and spillways for signs of erosion, damage or obstructions. Examine trap banks for seepage and structural soundness. Remove accumulated sediment when the storage trap is 1/3 full.

To assist with vector control, vegetation should be removed from the basin frequently.



Sediment is allowed to settle out of the runoff. The overflow structure discharges the clean water to the storm system.

## 4.17 ACTIVE TREATMENT SYSTEMS (ATS)

### DESCRIPTION

An active treatment system is required when traditional erosion and sediment applications are not effective and when zero discharge is a condition of construction for a project. One key distinction between this BMP and others, is that it is “Active” (requires power source).

These systems require detailed analysis of site conditions and the hydrology associated with the site’s stormwater management. The system is designed by the project engineer, and managed and maintained by certified ATS personnel.

The primary treatment process with an ATS is the employment of chemical coagulation, chemical flocculation, or electrocoagulation in order to reduce turbidity caused by suspended sediments. Any chemical materials specified in the ATS must be approved by the California State Water Resources Control Board (SWRCB). These systems usually require review and approval by the Regional Water Quality Control Board (Region 2).

### APPLICABILITY

Use this BMP, per the design criteria and requirements described in the SWRCB Construction General Permit (CGP) when:

- Discharging to turbidity sensitive waters, and turbidity reduction by other BMPs are

insufficient

- Where site constraints limit the ability to construct a properly sized sediment trap; or
- Where use is required by the CGP.

### GUIDELINES

Chemically treated stormwater discharged from construction sites should:

- Be designed and approved by a Certified Professional In Erosion and Sediment Control (CPESC), a Certified Professional in Stormwater Quality (CPSWQ), or a California registered civil engineer.
- Meet residual chemical and toxicity requirements as defined in the CGP.
- Include a filtration step between the coagulant treatment train and the effluent discharge.
- Be done in accordance with all local, state, and federal laws and regulations.
- Should be equipped with instrumentation that automatically measures and records effluent water quality data and flow rate.
- Comply with all provisions and prohibitions in the CGP.



Active treatment system being used at a sewer replacement project in downtown San Francisco



Active treatment system being used at a sewer replacement project in downtown San Francisco

## 4.17 ACTIVE TREATMENT SYSTEMS (ATS)

---

- The project shall have a site-specific Operation and Maintenance (O&M) manual covering the procedures required to install, operate and maintain the ATS.
- Operators shall have training specific to using an ATS and liquid coagulants for storm water discharges.
- Any discharger who deploys an ATS on their site shall conduct the daily visual monitoring and record findings in the project data log.

### **MAINTENANCE AND INSPECTION**

Daily on-site visual monitoring of the ATS operation and performance shall be done by a qualified person as required. The name and phone number of the qualified person assigned the responsibility of operation and monitoring of the system, and documentation of the qualified person's training as required by the statewide General Construction Stormwater Permit will need to be provided on site.

ATS require continuous monitoring when operating. Special attention needs to be given to ATS whenever they are being started up for the first time, restarted after an extended down time, and after maintenance or repair work has been done on the system.







# BEST MANAGEMENT PRACTICES



# 5

# NON-STORMWATER AND WASTE/MATERIAL MANAGEMENT

## IN THIS CHAPTER:

- |     |                                |      |                              |
|-----|--------------------------------|------|------------------------------|
| 5.1 | Water Conservation             | 5.8  | Solid Waste                  |
| 5.2 | Concrete Management            | 5.9  | Liquid Waste                 |
| 5.3 | Paving and Grinding Operations | 5.10 | Spill Prevention and Control |
| 5.4 | Material Delivery and Storage  | 5.11 | Contaminated Soil            |
| 5.5 | Stockpile Management           | 5.12 | Paint and Stucco             |
| 5.6 | Sanitary Waste                 | 5.13 | Illicit Connection/Discharge |
| 5.7 | Hazardous Waste                | 5.14 | Dewatering Operations        |



# 5.1 WATER CONSERVATION

---

## DESCRIPTION

This BMP reduces the amount of water consumed for a given activity, thereby reducing the chance of erosion and transport of pollutants off-site.

## GUIDELINES

- Avoid overfilling watering equipment. If overfilling persists, stabilize the area, and provide means to control the runoff.
- Discourage on-site vehicle and equipment washing.
- Avoid cleaning construction areas with water. If water must be used, first sweep and vacuum to minimize amount of water needed.
- Always protect storm drain inlets or natural waterways from sediment and pollutants generated by watering activities.
- Direct non-polluted runoff into areas on-site where it can percolate into the ground or be collected and reused.
- Water equipment should be kept in good working order.
- Always promptly repair leaky watering equipment.
- Lock water tank valves to prevent unauthorized use.

## MAINTENANCE AND INSPECTION

Inspect water equipment at least weekly, and repair as needed:

- Water trucks
- Water reservoirs
- Irrigation systems
- Hydrant connections

Inspect all non-stormwater management BMPs daily when discharge occurs.

## 5.2 CONCRETE MANAGEMENT

### DESCRIPTION

Concrete management includes the proper procedures to reduce or eliminate the contamination of stormwater runoff during concrete curing, cutting, drilling and coring. Discharges of stormwater and non-stormwater exposed to these concrete activities may have a high pH and may contain chemicals, metals, and fines. Proper procedures reduce or eliminate the contamination of stormwater runoff during these procedures

### GUIDELINES

This BMP is suitable for all projects where Portland Cement Concrete (PCC) and concrete curing chemicals are placed where they can be exposed to rainfall, runoff from other areas, or where runoff from the PCC will leave the site. Concrete management is also applicable on projects where asphalt is used or where slurry or pavement/concrete wastes are generated by construction activities, including: sawcutting, coring/drilling, grinding, repaving or patching, and encasing conduit in concrete.

All operations shall adequately mitigate polluted water discharge:

- Capture all runoff from curing operations in a lined or otherwise impervious containment area. Use of a concrete washout is required on all sites prior to concrete pour.

- Transport discharge to an approved off-site disposal area, or propose alternate methods of treatment disposal (to be reviewed by the City).
- Residual from concrete and asphalt concrete saw-cutting operations shall be removed with a commercial vacuum or pump.
- The downstream drain inlets and catch basins shall always be protected during concrete operations.
- During or just before rain events, concrete disposal or work must not be performed.
- Prevent wash out from mixers, buckets, mortar boxes, and tools from spilling onto bare ground.
- Minimize the amount of water used during coring/drilling or sawcutting. During wet coring or sawcutting, use a shovel or wet vacuum to lift the slurry from the pavement.

### MAINTENANCE AND INSPECTION

- Inspect containment structures prior to rainfall and prior to and during use. Required repairs must be done before a rain event, and in a timely manner.
- At the end of a shift or after use, ensure containment structures and the general work area are clean. Properly dispose of all wastes.



Runoff from the curing operation is captured in a concrete washout.



Wastes from concrete curing are not contained, and are open to contact with runoff.

## 5.3 PAVING AND GRINDING OPERATIONS

### DESCRIPTION

This section discusses the handling of materials and wastes for (and the use of equipment associated with) pavement preparation, paving, surfacing, resurfacing, paint striping, thermoplastic striping and placement and the removal of all the above.

### GUIDELINES

- Install BMPs prior to beginning paving and grinding operations.
- Avoid paving during wet season.
- Collect and remove grindings and wastes from removal of pavement and related materials as the work progresses.
- Temporary waste stock piles containing wastes from paving and grinding need to be covered with plastic sheeting until removed from the site.
- Asphalt concrete placement and removal equipment needs to be cleaned off-site.
- Do not apply seal coat, tack coat, slurry seal or fog seal during rain or if rain is expected during curing period. If unexpected rain occurs, capture all runoff from treated areas, and dispose off-site.
- Prior to operation, verify that shut-off valves are operable on painting and thermoplastic applying equipment. Do not overfill the thermoplastic pre-heater to prevent spills. Clean truck beds daily and recycle thermoplastic material when

possible.

- Do not transfer or load bituminous materials near storm drains or natural waterways.

### MAINTENANCE AND INSPECTION

Inspect and maintain machinery regularly to minimize potential leaks.



Inactive paving equipment is properly stored with perimeter protection.



## 5.4 MATERIAL DELIVERY AND STORAGE

### DESCRIPTION

This BMP provides the proper procedures for delivery and storage of the following:

- Soil stabilizers and binders
- Detergents
- Plaster
- Petroleum products such as fuel, oil and grease
- Asphalt and concrete components
- Hazardous compounds such as acids, lime, glues, adhesives, paints, solvents and curing compounds

### GUIDELINES

#### Outdoor Loading Areas

- Grade the area or construct a low berm to prevent run-on of stormwater and runoff of spills, or provide a roof/seal/door skirt to keep out rain.
- Prevent roof runoff from draining onto loading area.

#### Storage

- Construction materials must be stored onsite at all times. Storing materials together in a staging area will make it easier to cover them to prevent runoff caused by wind or rain.
- Only exception is possession of a right-of-way permit.
- Store materials away from outside drains and high traffic.
- Keep chemicals in their original labeled

container.

- Chemical storage areas must have spill kits.
- Materials must be labeled.
- Petroleum products (fuels and oils) should be stored in approved containers and should not be overfilled. Containers should be placed in temporary containment facilities for storage.
- Compressed gases:
  - Label cylinders with contents
  - Secure cylinders from falling
  - Nation Fire Protection Association (NFPA) symbol posted in storage area.
- Store oxygen at least 25 feet away from fuel.
- Separate cylinders in bulk storage from incompatible materials by fine barriers or by appropriate distance.
- Stored items in contained areas to prevent leaks or spills from directly/indirectly entering storm drains.
- The storage volume within the containment area should be 10% greater than the total volume of all containers.
- Secondary containment for hazardous materials, liquids and solids. Design secondary containment for outdoor storage areas to contain a spill from the largest individual vessel. If the area is open to rainfall, design secondary containment to include the volume of

a 24-hour rainfall as determined by a 25 year storm, and make provisions to drain accumulations of groundwater and rainwater.



These materials are covered but require a secondary containment facility for storage.

## 5.4 MATERIAL DELIVERY AND STORAGE

### Material Safety Data Sheets (MSDS)

The project site manager needs to have available all MSDS for all toxic materials and liquids used and stored on the site. Storage instructions should be posted, and employees need to be trained in proper storage and delivery procedures.

### Hazardous Materials

Store hazardous materials in their original containers with their original product labels attached. Do not store incompatible materials in the same temporary storage facility. Allow sufficient space between storage containers to allow for spill cleanup and emergency response access.

- Ensure that adequate storage volume is provided and is located as far away as possible from storm drains, natural waterways and drainage channels. Secondary containment should be impervious to spilled wastes. Supply equipment storage areas with appropriate spill cleanup materials.
- Secondary containment must be kept clean, dry, and free of debris.  
Additional containment requirements:
  - Capable of holding 110 percent of material stored (unless exposed to rain)
  - Lining to remain intact
  - No materials overhanging berms
  - No materials stored on berms
  - No flammable materials used to form berms
- Post the NFPA symbol at storage area.



Materials are stored in bins but there is leakage, discarded oil cans, and uncovered containers.

## 5.5 STOCKPILE MANAGEMENT

### DESCRIPTION

This BMP describes proper procedures for stockpiling construction material. Stockpile protection is a year round requirement.

### GUIDELINES

#### Soil stockpiles:

- Soil or gravel stockpiles must be stored onsite. During the rainy season, these stockpiles must be covered with a tarp each day.
- When in use, all exposed soil piles must be sprayed with water to prevent excessive dust.
- If a soil stockpile is to remain inactive for a season, consider hydroseeding the pile or using vegetation to stabilize it.

#### Other stockpiles:

- Install temporary barriers around the stockpile perimeter to prevent contact with runoff. Temporary barriers may be berms, dikes, silt fences, fiber rolls and gravel bag berms. Attach hydrocarbon booms to barrier if stockpiling asphalt. Hydrocarbon is part of the crude oil mixture that makes asphalt. The booms absorb the oil and prevent it from leaving the site.
- Place active and inactive cold-mix stockpiles on plastic sheeting or tarps, and securely cover them.

### MAINTENANCE AND INSPECTION

Stockpiles should be checked weekly, prior to rain events, daily during extended rain events, and after rain events. Remove sediment from stockpile perimeter controls when sediment reaches 1/3 of the barrier height.

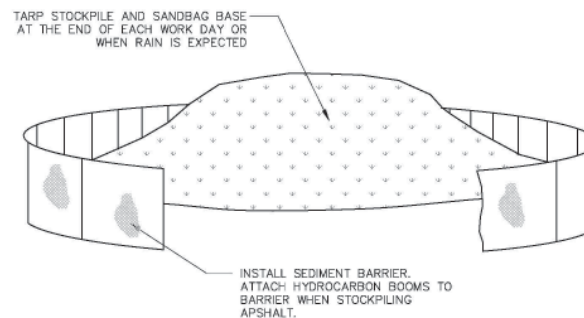

A properly protected stockpile with a plastic cover anchored down by gravel bags.



Asphalt debris is escaping from this poorly installed stockpile. Asphalt can release pollutants like hydrocarbons when not properly contained.



## 5.6 SANITARY WASTE

### DESCRIPTION

Measures must be taken to keep waste from portable sanitary facilities out of the storm drain system, natural waterways or channels. Discharges to the City's sanitary sewer system are not allowed from sanitary facilities.

### GUIDELINES

- Locate temporary sanitary facilities behind sidewalks and away from storm drain inlets, natural waterways, channels and traffic areas.
- Anchor the sanitary facility to the ground as a precaution for both vandalism and high winds.
- Do not discharge, dump or bury wastewater on private or public property.
- If a spill occurs from the facilities, follow federal, state and local regulations for containment and clean-up.

### MAINTENANCE AND INSPECTION

The general contractor monitors any sanitary/septic waste storage and disposal procedures on a weekly basis. The contractor is responsible for ensuring that the sanitary/septic facilities are maintained in good working order and wastes are transported offsite by a licensed sanitary service provider.



Improper disposal of sanitary wastes.



Properly installed portable sanitary facilities.

## 5.7 HAZARDOUS WASTE

### DESCRIPTION

This section describes proper hazardous waste handling procedures to prevent associated pollutants from entering stormwater.

Hazardous waste includes but is not limited to the following substances: petroleum products, concrete curing compounds, sanitary wastes, paints, stains, wood preservatives, asphalt products, pesticides, acids, solvents and roofing tar. If non-hazardous waste comes into contact with the above wastes, it is considered hazardous.

Sites with existing structures may contain wastes which must be disposed of in accordance with Federal, State, and local regulations, including: sandblasting grit mixed with lead, cadmium, or chromium-based paints; asbestos; and polychlorinated biphenyls (PCBs).

### GUIDELINES

- Refer to the applicable Material Safety Data Sheet (MSDS) for clean-up and reporting procedures for all hazardous spills.
- Do not remove the original product label; it contains important safety and disposal information.
- Use secondary containment berms in fueling areas.
- Place hazardous waste collection containers at convenient locations.
- All hazardous waste must be stored within secondary containment.
- See Hazardous Materials BMP Section for additional guidelines.
- Containers properly labeled: name, address, and US Environmental Protection Agency (EPA) identification (ID) number or ID number of generator listed (not required if contractor is an exempt small quantity generator).
- Do not store different wastes in the same container. Do not store incompatible materials in the same temporary containment facility.
- Hazardous waste shall be transported from the site by a licensed hazardous waste transporter and disposed of at an authorized, licensed disposal or recycling facility within 90 days of being accumulated.
- Properly dispose of rain water removed from temporary containment areas that may have mixed with hazardous waste.
- Educate contractor and subcontractors regarding identification, storage, and disposal of hazardous waste. Ongoing hazardous waste training should be included in regular safety meetings.



Runoff containing concrete admixtures from unprotected construction activities have made their way to a drainage inlet.

## 5.8 SOLID WASTE

### DESCRIPTION

Materials that are collected and disposed of on-site in solid waste storage bins cannot come in contact with stormwater runoff.

Solid wastes include items such as:

- Construction wastes including brick, mortar, timber, steel and metal scraps, pipe and electrical cuttings, non-hazardous equipment parts, styrofoam and other materials used to transport and package construction materials.
- Scrap or surplus building materials including metals, rubber, plastic, glass pieces and masonry products.
- Domestic wastes including food containers such as beverage cans, coffee cups, paper bags, plastic wrappers, and cigarettes.
- Planting wastes, including vegetative material, plant containers, and packaging materials.

### GUIDELINES

- Solid waste should be stored at a location which is least likely to be flooded, and at a location away from a storm drain, natural waterway or drainage channel.
- Use berms, dikes or other temporary diversion structures to protect stockpiled waste from contacting stormwater.

- During rain events, waste materials need to be stored in watertight dumpsters and kept securely covered. Liquids must be kept out of dumpsters and waste receptacles. The areas around the dumpsters should be swept daily.
- Provide an adequate number of trash receptacles on-site including field trailer areas and where workers gather for breaks except near drainage inlets, natural waterways or drainage channels. All litter within the construction site should be collected weekly, regardless of the litter's origin. Litter needs to be removed from the site by a licensed solid waste contractor.
- Provide an adequate amount of watertight dumpsters to collect the anticipated volume of construction waste. Also, plan for additional dumpsters to be delivered to the site and schedule additional pickups during demolition phases. Washing out dumpsters on the construction site is prohibited.

### MAINTENANCE AND INSPECTION

Construction debris and waste should be removed from the site biweekly or more frequently as needed. Arrange for regular waste collection.



There are no dumpsters, containers or diversion structures to stop stormwater runoff from coming in contact with this construction litter and debris.



## 5.9 LIQUID WASTE

### DESCRIPTION

This section describes proper procedures to prevent non-hazardous liquid wastes from entering the storm drain system. This section does not apply to the following: dewatering operations, solid wastes, hazardous wastes, concrete slurries, and liquid wastes covered by specific laws or permits.

This BMP addresses non-hazardous liquid wastes:

- Drilling slurries and fluids
- Dredgings
- Other non-storm water liquid discharges, which are not covered by separate permits
- Grease and oil-free wastewater and rinse water

### GUIDELINES

- Use temporary dikes or berms to direct surface flow of liquid wastes to a containment structure or device. The containment area should be structurally sound, leak free, and have sufficient storage for anticipated volume.
- Appropriate structures include holding pits, sediment basins, roll off bins and portable tanks. Locate the containment structure far from storm drains, natural waterways and drainage channels.
- Some liquid wastes may require testing and certification that they are non-hazardous before an appropriate disposal

method is selected.

- Educate employees and subcontractors on liquid waste generating activities and liquid waste storage and disposal procedures.
- Refer to Vehicle and Equipment Cleaning BMP when applicable.
- Avoid spills or accidental releases of contained liquid wastes. Apply Spill Prevention and Control BMPs as needed.

### MAINTENANCE AND INSPECTION

- Remove deposited solids in containment areas and capturing devices as needed, and at the completion of the task. Dispose of any solids as described in Solid Waste BMP on pg. 76.
- Inspect containment areas and capturing devices and repair as needed.
- Frequently inspect liquid waste containment areas and capturing devices for damage, and repair as needed.



Drilling fluids from a small residence project are leaving the site untreated.



The waste runs into the street allowing pollutants to enter the City storm drain system.

## 5.10 SPILL PREVENTION AND CONTROL

### DESCRIPTION

Spill prevention and prompt appropriate spill response reduces the potential for discharging pollutants to drainage system. Typical spills of concern include chemicals and hazardous waste such as soil stabilizers/binders, dust palliatives, herbicides, growth inhibitors, fertilizers, petroleum products, fuels, pesticides, lubricants, paints and solvents.

### GUIDELINES

In preparation of a potential spill, locate and clearly label spill-kits and disposal containers. Appropriateness of the response is determined by the quantity and/or composition of the spilled substance as follows:

- **Minor Spill** - Small quantity of oil, gas, paint, etc, that can be controlled by the first responder at the scene. Instructions: contain the spill, recover the spilled material, clean the spill area and dispose of cleanup materials appropriately.
- **Semi-Significant Spill** - Can be controlled by the first responder with the aid of another person, and the spill may require the stopping of all other activity. On impermeable surfaces, surround the spill with absorbent material to contain it. Clean spill using absorbent material. On dirt areas, construct an earthen dike to contain the spill. Dig up contaminated

soil and dispose of properly. If spill occurs in rain, cover spill area to prevent contaminating stormwater runoff.

- **Significant/Hazardous Spill** - Significant spills cannot be controlled by personnel in the immediate vicinity. In the event of a significant spill the discharger should immediately call 911. Additionally, the discharger should call 311. Contractor's staff should not attempt to clean up until qualified assistance has arrived on-site.

### MAINTENANCE AND INSPECTION

- Keep ample supplies of spill control and cleanup materials on-site, near storage, unloading, and maintenance areas.
- Update the spill prevention and control plan, and stock cleanup materials as changes occur in the types of chemicals on-site.



Minor oil spills need to be cleaned to prevent them from running into the storm drain system.

## 5.11 CONTAMINATED SOIL

### DESCRIPTION

This section is particularly applicable when conducting construction in highly urbanized or industrial areas where soil contamination may have occurred due to spills, illicit discharges, and leaks from underground storage tanks.

### GUIDELINES

The procedures and practices presented in this BMP are general. The contractor should identify appropriate practices and procedures for the specific contaminants known to exist or discovered on-site.

It is important to confirm a site assessment before moving earth.

- Identify contaminated soils by investigating the following items. All suspected soils should be tested at a certified laboratory.
- Past site uses and activities.
- Detected or undetected spills and leaks.
- Acid or alkaline solutions from exposed soil or rock formations high in acid or alkaline forming elements.
- Contaminated soil as evidenced by discoloration, odors, differences in soil properties, abandoned underground tanks or pipes, or buried debris.
- Contaminated soil is prohibited from entering storm drains, natural waterways or drainage channels.

- Depending on the type of contamination, different handling requirements will need to be met. In some cases contaminated soils may need to be placed in steel barrels, sealed and removed from the site. This waste will need to be taken to a licensed hazardous waste disposal site. Along with this, soil testing for contaminants in stormwater may be required at the discretion of the Construction or Stormwater Inspector.
- Avoid stockpiling contaminated soils. If stockpiling is necessary and allowed, cover the stockpile and install a berm around the pile to prevent runoff for secondary containment.



Soil from this City site, which sits on an old industrial area, needs to be tested at a certified laboratory.



## 5.12 PAINT AND STUCCO

### DESCRIPTION

This section describes how to properly store and dispose of paint and stucco as well as their tools.

### GUIDELINES

Contact the City and County of San Francisco's SFEnvironment to locate facilities that accept paint cans, paint, solvents, and thinners.

- All paint and stucco materials stored on-site must be contained and covered.
- It is illegal for contractors to wash out paintbrushes in the street or dump any residues in the sewer or storm drain.
- Paintbrushes, spray guns, and other tools must be washed/cleaned out into a hazardous materials barrel or original container. Avoid doing this where wash water can flow to the storm drain, even if the paint is latex.
- Paint out brushes as much as possible. Always wash brushes with latex paint in a sink that goes to the sanitary sewer.
- Clean up latex paint spills with rags and wash in the sink. Avoid using oil-based paints, which require solvents. Filter and reuse thinners and solvents.



Dry out empty paint cans prior to disposal.

## 5.13 ILLICIT CONNECTION/DISCHARGE WASTE

### DESCRIPTION

This section describes how to recognize and report illicit connections or illegally discharged material on a construction site. Illicit discharges are generally any discharge into a storm drain system that is not composed entirely of stormwater.

### GUIDELINES

Before beginning the job, inspect the site for evidence of illicit connections, illegal dumping or discharges. Observe site perimeter for evidence for potential of illicitly discharged or illegally dumped material, which may enter the job site.

#### Identification:

- Treat unlabeled and unidentifiable material as dangerous hazardous materials.
- Solids – Look for debris piles. Solid waste dumping often occurs on roadways with light traffic loads or in areas not easily visible from the traveled way.
- Liquids – signs of illegal liquid dumping or discharge can include:
  - Visible signs of staining or unusual colors to the pavement or surrounding adjacent soils.
  - Pungent odors coming from the drainage systems.
  - Discoloration or oily substances in the water, or stains and residues detained within drainage structures

- In urban areas, be aware of:
  - Abnormal water flow during the dry weather season.
  - Pungent odors coming from the drainage systems.
  - Discoloration or oily substances in the water or stains and residues detained within ditches, channels or drain boxes.
  - Excessive sediment deposits, particularly adjacent to or near active off-site construction projects.



Untreated runoff from an upstream construction site is being discharged to the City storm system.



Contractors are illegally pumping unfiltered site runoff directly into the storm system.

## 5.13 ILLICIT CONNECTION/DISCHARGE WASTE

### Reporting:

- Notify the owner of any illicit connections and illegal dumping or discharge incidents at the time of discovery.
- To report illegal dumping, call 311. Examples of illegal dumping include leaving bulky items, such as couches and mattresses, garbage bags, or any debris on city sidewalks.

**Cleanup and Removal:** Contractors, site supervisors and property owners are responsible for preventing illicit discharges, and for reimbursing the City for expenses associated with clean up and removal.

### MAINTENANCE INSPECTION

Inspect the site regularly to check for any illegal dumping or discharge. Prohibit employees and subcontractors from disposing of non-job related debris or materials at the construction site.



Illegal trash dumping on a construction site.



## 5.14 DEWATERING OPERATIONS

### DESCRIPTION

Dewatering operations include the proper procedures for managing the discharge of stormwater and non-stormwater from the construction site.

### GUIDELINES

- Sediment treatment options include: sediment traps, dewatering tanks, weir tanks, cartridge filters and pressurized bag filters. See the CalTrans Dewatering Operations guidelines for further information regarding the tanks and filters.
  - The contractor is to provide a dewatering plan that details the location of dewatering activities, equipment and discharge point.
  - Retain water on the site for construction use. Re-use water for dust control, irrigation or another on-site purpose to the greatest extent possible.
  - Discharging construction site waste to the sanitary sewer is a final option and requires a Batch Wastewater Permit.
  - Appropriate wastewater treatment or off-site disposal will be required in those situations where the initial sampling and analysis reveal noncompliance with the applicable regulatory limits.
  - When flushing chlorinated water lines, test and remove all chlorine content before discharging to the sewer system.
- Dewatering discharges must not cause erosion at the discharge point

### MAINTENANCE AND INSPECTION

Inspect all BMPs frequently, and repair or replace to ensure the BMPs function as designed. Accumulated sediment removed during maintenance of a dewatering device must be disposed of according to the Registered Engineer. If the sediment contains hazardous pollutants, it must be removed in accordance with the guidelines for Hazardous Waste on pg. 75.



Polluted construction site runoff



Treated construction site runoff

# BEST MANAGEMENT PRACTICES



# APPENDIX



## IN THIS CHAPTER:

- 6 .1 Standard Notes for Erosion Control Plan
- 6 .2 Sample Erosion and Sediment Control Plan



## 6.1 STANDARD NOTES FOR EROSION CONTROL PLAN

Include erosion and sediment control notes on all plans. Additional notes are required to direct the contractors and crew on site specific conditions.

1. THIS PLAN MAY NOT COVER ALL THE SITUATIONS OR PHASES THAT ARISE DURING CONSTRUCTION DUE TO UNANTICIPATED FIELD CONDITIONS. IN GENERAL, THE CONTRACTOR IS RESPONSIBLE FOR KEEPING SEDIMENT STORM RUNOFF FROM LEAVING THE SITE. SEDIMENT ROLLS AND SILT FENCES SHALL BE USED BY THE CONTRACTOR ON AN AS NEEDED BASIS TO INHIBIT SILT FROM LEAVING THE SITE AND ENTERING THE STORM DRAIN SYSTEM. TEMPORARY EROSION CONTROL DEVICES SHOWN ON GRADING PLAN WHICH INTERFERE WITH THE WORK SHALL BE RELOCATED OR MODIFIED WHEN THE INSPECTOR SO DIRECTS AS THE WORK PROGRESSES.
2. EROSION CONTROL FACILITIES SHALL BE MAINTAINED DAILY. THESE FACILITIES SHALL CONTROL AND CONTAIN EROSION-CAUSED SILT DEPOSITS AND PROVIDE FOR THE SAFE DISCHARGE OF SILT FREE STORM WATER INTO EXISTING AND PROPOSED STORM DRAIN FACILITIES. DESIGN OF THESE FACILITIES MUST BE APPROVED AND UPDATED EACH YEAR BY THE ENGINEER (OCTOBER 1 TO APRIL 15).
3. ALL EROSION AND SEDIMENT CONTROL MEASURES SHALL BE CONSTRUCTED AND MAINTAINED IN ACCORDANCE WITH THE PROVISIONS OF THE ENGINEERING DIVISION OF THE PUBLIC SERVICES DEPARTMENT OR CITY OF SAN FRANCISCO DEPARTMENT OF PUBLIC WORKS. CONTROL MEASURES ARE SUBJECT TO THE INSPECTION AND APPROVAL OF THE ENGINEERING DIVISION OF THE PUBLIC SERVICES DEPARTMENT OR CITY OF SAN FRANCISCO DEPARTMENT OF PUBLIC WORKS.
4. THE CONTRACTOR IS RESPONSIBLE FOR ENSURING THAT ALL SUB-CONTRACTORS AND SUPPLIERS ARE AWARE OF ALL STORM WATER QUALITY MEASURES & IMPLEMENT SUCH MEASURES. FAILURE TO COMPLY WITH THE APPROVED CONSTRUCTION WILL RESULT IN THE ISSUANCE OF CORRECTION NOTICES, CITATIONS, AND / OR A PROJECT STOP ORDER.
5. THE SITE SHALL BE MAINTAINED SO AS TO MINIMIZE SEDIMENT LADEN RUNOFF TO ANY STORM DRAIN SYSTEM.
6. IF EXISTING DRIVEWAY IS REMOVED DURING CONSTRUCTION, THE CONTRACTOR SHALL PLACE DRAIN ROCK AS A GRAVEL ROADWAY (8" MINIMUM THICKNESS FOR THE FULL WIDTH AND LENGTH OF SITE EGRESS AREA AS DEFINED IN THESE PLANS) AT ENTRANCE TO THE SITE. LOCATION TO BE APPROVED BY CITY ENGINEER IN THE FIELD. CONSTRUCTION EGRESS SHALL BE EQUIPPED WITH A TRUCK WASHING STATION. ALL TRUCKS SHALL WASH TIRES AND UNDERSIDE OF VEHICLES AS APPROPRIATE WHEN LEAVING THE SITE. ANY MUD THAT IS TRACKED ONTO PUBLIC STREETS SHALL BE REMOVED THE SAME DAY AS REQUIRED BY THE CITY ENGINEER.
7. DURING THE RAINY SEASON, ALL PAVED AREAS ARE TO BE KEPT CLEAR OF EARTH MATERIAL AND DEBRIS. THE SITE IS TO BE MAINTAINED SO AS TO MINIMIZE SEDIMENT RUNOFF TO ANY STORM DRAIN SYSTEM.
8. DURING PERIODS WHEN STORMS ARE FORECAST:
  - A. EXCAVATED SOILS SHOULD NOT BE PLACED IN STREETS OR ON PAVED AREAS.
  - B. ANY EXCAVATED SOILS SHOULD BE REMOVED FROM THE SITE BY THE END OF THE DAY.
  - C. WHERE STOCKPILING IS NECESSARY, USE A TARPAULIN OR SURROUND THE STOCKPILED MATERIAL WITH FIBER ROLLS, GRAVEL SEDIMENT BARRIER, SILT FENCE, OR OTHER RUNOFF CONTROLS.
  - D. USE INLET CONTROLS AS NEEDED (E.G. BLOCK & GRAVEL SEDIMENT BARRIER) FOR STORM DRAIN ADJACENT TO THE PROJECT SITE OR STOCKPILED SOIL.
9. THOROUGHLY SWEEP ALL PAVED AREAS EXPOSED TO SOIL EXCAVATION AND PLACEMENT.
10. STAND-BY CREWS SHALL BE ALERTED BY THE PERMIT APPLICANT OR CONTRACTOR FOR EMERGENCY WORK DURING RAINSTORMS.
11. AFTER OCTOBER 1ST TO APRIL 15TH, ALL EROSION CONTROL MEASURES WILL BE INSPECTED DAILY AND AFTER EACH STORM. BREACHES IN DIKES AND TEMPORARY SWALES WILL BE REPAIRED AT THE CLOSE OF EACH DAY AND WHENEVER RAIN IS FORECAST.
12. AS A PART OF THE EROSION CONTROL MEASURES, UNDERGROUND STORM DRAIN FACILITIES SHALL BE INSTALLED COMPLETE AS SHOWN ON THE IMPROVEMENT PLANS.
13. BORROW AREAS AND TEMPORARY STOCKPILES SHALL BE PROTECTED WITH APPROPRIATE EROSION CONTROL MEASURES TO THE SATISFACTION OF THE CITY ENGINEER.
14. SANDBAGS SHALL BE STOCKPILED ON SITE AND PLACED AT INTERVALS SHOWN ON EROSION CONTROL PLANS, WHEN THE RAIN FORECAST IS 40% OR GREATER, OR WHEN DIRECTED BY THE INSPECTOR.
15. SANDBAGS REFERRED TO IN THE PRECEDING ITEMS MUST BE FULL. APPROVED SANDBAG FILL MATERIALS ARE SAND, DECOMPOSED GRANITE AND/OR GRAVEL, OR OTHER MATERIALS APPROVED BY THE INSPECTOR.
16. CONTRACTOR SHALL BE RESPONSIBLE FOR ENSURING SAFETY OF VEHICLES OPERATING IN ROADWAY ADJACENT TO EROSION CONTROL FACILITIES.
17. AFTER RAINSTORMS CONTRACTOR SHALL CHECK FOR AND REMOVE SEDIMENT TRAPPED BY SAND BAGS AT STAGING AREA. REPLACE SAND BAGS IF DETERIORATION IS EVIDENT.
18. DUST CONTROL SHOULD BE PRACTICED ON ALL CONSTRUCTION SITES WITH EXPOSED SOILS AS NEEDED. IT IS IMPORTANT IN WINDY OR WIND-PRONE AREAS. DUST CONTROL IS CONSIDERED A TEMPORARY MEASURE AND AS AN INTERMEDIATE TREATMENT BETWEEN SITE DISTURBANCE AND CONSTRUCTION, PAVING, OR REVEGETATION. REFER TO EROSION CONTROL AND SEDIMENT CONTROL FIELD MANUAL, 3RD EDITION, PREPARED BY THE CALIFORNIA REGIONAL WATER QUALITY CONTROL BOARD, SAN FRANCISCO BAY REGION.

# 6.2 SAMPLE EROSION & SEDIMENT CONTROL PLAN

